



2N[®] Helios

Door Access Communicator



User Manual

Version 3.1
Firmware version 11.02.02

www.satelco.ch

The 2N TELEKOMUNIKACE a.s. joint-stock company is a Czech manufacturer and supplier of telecommunications equipment.



The product family developed by 2N TELEKOMUNIKACE a.s. includes GSM gateways, private branch exchanges (PBX), and door and lift communicators.

2N TELEKOMUNIKACE a.s. has been ranked among the Czech top companies for years and represented a symbol of stability and prosperity on the telecommunications market for almost two decades. At present, we export our products into over 120 countries worldwide and have exclusive distributors on all continents.



2N[®] is a registered trademark of 2N TELEKOMUNIKACE a.s.. Any product and/or other names mentioned herein are registered trademarks and/or trademarks or brands protected by law.



2N TELEKOMUNIKACE administers the FAQ database to help you quickly find information and to answer your questions about 2N products and services. On faq.2n.cz you can find information regarding products adjustment and instructions for optimum use and procedures „What to do if...“.



Declaration of Conformity

2N TELEKOMUNIKACE a.s. hereby declares that the 2N[®] Helios product complies with all basic requirements and other relevant provisions of the 1999/5/EC directive. For the full wording of the Declaration of Conformity see the CD-ROM enclosed and at www.2n.cz.



The 2N TELEKOMUNIKACE company is a holder of the ISO 9001:2008 certificate. All development, production and distribution processes of the company are managed by this standard and guarantee a high quality and advanced technical level of and a professional approach to all of our products.

Contents

1. Product Overview.....	7
1.1 Product Description	8
Basic Features.....	9
Advantages of Use	9
1.2 Changes	10
1.3 2N® Helios Components and Associated Products.....	11
Basic and Extender Units	11
Installation Accessories	12
Increased Resistance Accessories	13
GSM and VOIP Connection Accessories.....	13
Video Accessories	14
Electric Locks	14
Card Readers	15
Other Accessories	15
1.4 Terms and Symbols Used	16
Terminology.....	16
Manual Symbols	17
2. Description and Installation.....	19
Button Numbering	19
2.1 Before You Start	21
Product Completeness Check.....	21
2.2 Mounting – Mechanical Installation.....	22
Overview of Installation Types	22
Surface Mounting	23
Flush Mounting	24
Vandal Resistant Mounting	24
2.3 Electrical Installation	25
Compatibility	25
Connection to Telephone Line	25
Printed Circuit Board (PCB) Description	25
Description of Terminals.....	28
Description of Jumpers.....	28
Parallel Connection	28
Typical Electric Lock Connection	29
Typical Backlight Power Supply	30
Cable Arrangement inside the Cover	30
Grounding Terminal Connection - Mandatory	31
Separate Backlight and Electric Lock Supply.....	32

	Connection of Switch 2.....	32
2.4	Camera Installation	33
2.5	Extending Module Connection.....	34
	Module Cable Interconnection.....	34
	Maximum Count of Extenders	35
	Button Numbering	36
2.6	Buttons Labels – Insertion, Replacement.....	37
	Instructions	37
	Label Material and Printing.....	38
2.7	Mounting - Completion	39
	Most Frequent Mounting Errors.....	39
3.	2N[®] Helios Configuration	41
3.1	Programming	42
	Entering Programming Mode	42
	Programming Procedure	42
	Programming Error	43
	Deleting All Passwords, All Memories, Complete Initialisation	44
	If You Forget the Service Password.....	44
3.2	Full Parameter Chart	45
	Explanation of Some Parameters.....	49
4.	Function and Use	53
4.1	Function Description	54
	From External User's View (Visitor)	54
	Function Description – Numerical Keypad Models	54
	From Internal User's View (Survey of Functions).....	55
	Signals Overview.....	56
	Call Termination Options - Summary.....	57
	Code Lock	57
	Traditional Button Telephone	58
	DTMF Transmission during Outgoing Call	58
	Buttons Substitution	58
	Keypad Operation Instructions - Summary	59
	Frequently Asked Questions About Keypad Function.....	60
	2N [®] Helios Statuses and Available Operations.....	61
4.2	Section for Advanced Users	62
	Automatic Multiple Number Dialling	62
	Survey of Messages.....	65
	Arrival/Departure, Day/Night Modes.....	66
4.3	Maintenance.....	68
	Cleaning	68
	Label Replacement, Programming Status Changes.....	68

- 5. Technical Parameters69**
 - 5.1 **Technical Parameters 70**
 - Telephone Parameters 70
 - Other Parameters 71

- 6. Supplementary Information73**
 - 6.1 **Directives, Laws and Regulations 74**
 - 6.2 **Troubleshooting 75**
 - FAQ 75
 - 6.3 **General Instructions and Cautions 76**
 - Electric Waste and Used Battery Pack Handling 77

1

Product Overview

In this section, we introduce the **2N[®] Helios** product, outline its application options and highlight the advantages following from its use.

Here is what you can find in this section:

- Product Description
- Changes
- 2N[®] Helios Components and Associated Products
- Terminology

1.1 Product Description

The **2N® Helios** door communicator replaces a traditional door entry system which would traditionally have to have a whole cabled distribution infrastructure behind it. The connectivity of the unit is flexible in that as standard the unit can connect to any telephone system via either an analogue extension or trunk port. The 2N® Helios unit can also connect to any network provider's analogue telephone line.

2N® Helios is also easy to use. Just press the desired call button and **2N® Helios** will automatically 'dial' the number pre-stored in the respective memory. The number of buttons is flexible as **it** is a modular unit.

2N® Helios also has a switch that controls the electric lock by using any telephones keypad (by tone-dialling the password).

In addition to the buttons, you can use a numerical keypad, which is used as a code lock. Using the keypad, you can operate the device as a button telephone and dial the required numbers directly or retrieve them from any of the 54 memories available. You can disable non-desired functions.

2N® Helios provides improved and feature rich options compared with standard door entry systems, this is because you can make use of functions such as call redirection if not answered, or have a day and night mode set up for automatic redirection of the call for instance after normal working hours.

The **2N® Helios** parameters meet all technical requirements mandatory for devices designed for the PSTN (public switched telephone network) connection.

Basic Features

- Exclusive design, – high-grade stainless steel finish.
- Water resistant
- Exclusive white button backlight – white LEDs
- Modularity – up to 54 buttons + keypad
- Up to 16 buttons per unit.
- Each basic unit has a space for camera and card reader build-in modules
- Increased protection through optional Vandal Resistant panel.
- Telephone-controlled electronic lock switch
- Detection of all standard tones - hangs up automatically
- Easy, voice menu based remote programming via telephone.
- Applicable as a standard telephone and code lock (keypad version)

Advantages of Use

- Flat design – installation no need to cut into mounting surface
- Hermetically sealed, solid state buttons
- Electronics is separated from name plates
- Electronic volume and Hands-Free control – no need to open cover
- Operates on any analogue telephone line
- Stable line power feeding
- High acoustic quality
- Special functions includes automatic dialling of multiple numbers, silent dialling, departure/arrival, day/night mode, second switch delay

1.2 Changes

Version	Changes
2.0	<p>A new version of the communicator firmware released in April 2007. Marking: FW:07-02-22</p> <ul style="list-style-type: none">■ New voice functions – new parameters 974, 976 and 977■ Dual tone detection■ New factory setting for parameter 951■ Vandal resistant assortment upgraded
3.0	<p>New firmware version released in march 2011. Marking: FW:11.02.02</p> <ul style="list-style-type: none">■ Detection of all dual tones - new parameter 946■ New parameter 975 – extended message options for automatic calls■ New function 995 – software version identification■ Language selection: English, German, Portuguese, Dutch■ Programming: Cancelling by # is possible in any state

1.3 2N® Helios Components and Associated Products

Basic and Extender Units



Part No. 9135130E
Basic unit
3 buttons



Part No. 9135130KE
Basic unit
3 buttons + keypad



Part No. 9135181E
Extender unit
8 buttons

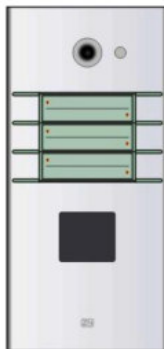

Part No. 9135160E
Basic unit
3x2 buttons



Part No. 9135160KE
Basic unit
3x2 buttons + keypad

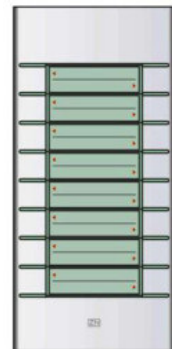

Part No. 913582E
Extender unit
8x2 buttons

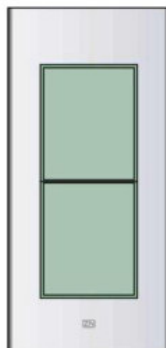

Part No. 9135310E

Info panel
A backlit button-less panel used for the telephone directory, house number, etc.

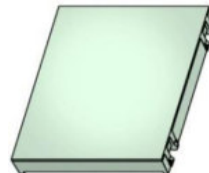

Part No. 9135311E

Info panel – name plate

Replaces four name plates with one cover. Enables the use of one half of the extender unit for the telephone directory, opening hours, etc.

All the above-mentioned units can be wall mounted without requiring any additional accessories. All the basic units can be complemented with a camera, proximity reader (see later) and display (under preparation). All units can be made more resistant using the Vandal resistant cover. Additional accessories (see later) are needed for outdoor flush mounting purposes.

Installation Accessories

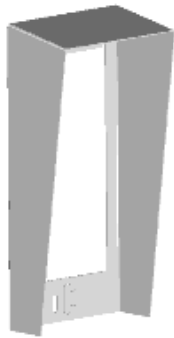

Part No. 9135331E

Surface 1-module roof

Dimensions

103×218×60 mm
(W×H×D)



Part No. 9135351E

Wall mounting box
with 1-module frame

Dimensions

125×235×46 mm
(W×H×D)

Wall hole

110×220×50 ±5 mm

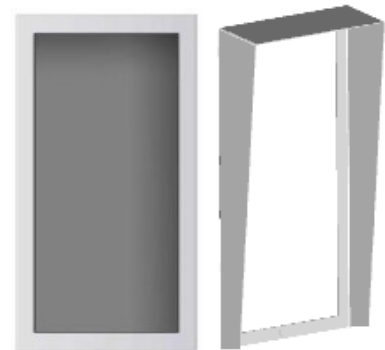

Part No. 9135361E

Wall mounting box
with 1-module roof

Roof dimensions

129×240×41 mm
(W×H×D)

Wall hole

110×220×50 ±5 mm

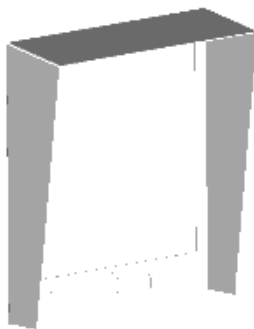

Part No. 9135332E

Surface 2-module roof

Dimensions

203×218×60 mm
(W×H×D)



Part No. 9135352E

Wall mounting box
with 2-module frame

Dimensions

225×235×46 mm
(W×H×D)

Wall hole

210×220×50 ±5mm

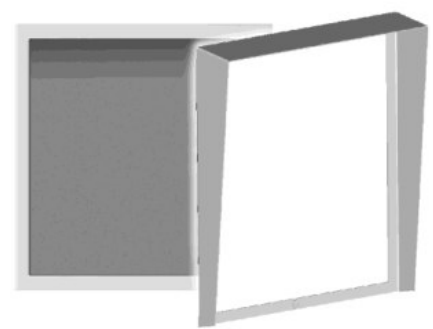

Part No. 9135362E

Wall mounting box
with 2-module roof

Roof dimensions

229×240×41 mm
(W×H×D)

Wall hole

210×220×50 ±5mm

The mounting accessories are made of "marine grade" stainless steel. For outdoor applications, the use of the roof is required unless weather protection is provided otherwise. The box with frame (without roof) allows for installation of 2N® Helios in indoor applications so that the unit does not practically stick out (up to 1 mm).

Increased Resistance Accessories



Part No. 9135511E

Vandal resistant mask
3-button basic module
+ Vandal resistant wall
mounting box



Part No. 9135511KE

Vandal resistant mask
3-button basic module
with keypad + Vandal
resistant wall mounting
box



Part No. 9135515E

Vandal resistant mask
8-buttons extending
module + Vandal resistant
wall mounting box



Notes

- Use these covers to make the basic units or sets with up to 11 buttons more resistant. Larger assemblies can be provided upon request.
- Be sure to use the more resistant version for flush mounting. No roof is required for outdoor applications of this version.



Warning

- Item No. **9135351E** cannot be used! Use a dedicated box for installation of the Vandal resistant mask!

GSM and VOIP Connection Accessories

EasyGate
GSM gateway
Part No.
501303E



Analogue/VoIP
gateway
Part No. 91341711E

Video Accessories



Part No. 9135210E
In-built colour CCD camera

PAL, resolution 420 TV rows, sensitivity 2 lux

The camera can be built in any basic unit. In the case of poor light, the camera switches into the monochrome mode automatically. Supplementary infrared light. Horizontal/vertical tilting option.



Part No. 9134147E
7" colour LCD monitor (TFT)

The selected model features a composite video signal input with high sensitivity for long cabling runs. Vivid colours, wide-angle display option, in-built TV set. The right to change the design is reserved.



Part No. 9134137E
MPEG4 LAN video server

Video records can be observed by anybody's PC via the LAN, no SW installation is needed. Serves up to 10 PCs at the same time. The MPEG-4 compression ensures the network load is approximately 10 times lower than uncompressed. The Internet can also be used to watch the video.. Quality / data flow control option. Free SW for intelligent recording of the video record into a PC (includes movement detection).

Electric Locks



Part No. 932070E
 BEFO 1211 12V / 600 mA



Part No. 932080E
 BEFO 1221
 with momentum pin



Part No. 932090E
 BEFO 1211MB
 with mechanical blocking

Card Readers



91341612WE

Built-in reader module for basic modules without keypad

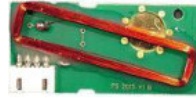

91341611WE

Reader set for basic modules with keypad

Both readers has a memory for 748 users and RS485 interface. Technology: EM Marin 125kHz



9134165E

Chip card



9134166E

Chip key fob

Other Accessories



Part No. 9135250E

Additional switch

Switching and breaking contact option, time-unlimited switching, up to 48 V / 2A.



Part No. 91341481E

12V / 2A adapter

A stabilised power supply must be used if a camera is installed. It can also feed the lock and backlight.



Part No. 9134148E

SIEMENS® adapter

This is required when connecting to a Siemens HiPath Telephone system



Part No. 932928E

12V Transformer



Part No. 9135301E

name plate



Part No. 9135302E

double-button name plate

1.4 Terms and Symbols Used

Terminology

- **Line pick-up/seizure/off-hook**
call start, line locked, busy.
- **Line hang-up/clear**
call end, handset hang-up.
- **DTMF**
dual tone multi-frequency signalling.
- **PSTN**
public switched telephone network.
- **Outgoing call**
2N® Helios-telephone connection made, e.g. by a pressing a button.
- **Incoming call**
telephone-2N® Helios connection.
- **Programming mode**
2N® Helios programming mode accessible from by dialling into the intercom only.
- **Code lock**
mode for entering the password for switch 1 or 2 activation using a numerical keypad.
- **Telephone mode**
you can make a call, dial a number and hang up using the numerical keypad.
- **DTMF transmission during call**
for outgoing calls only, numbers are tone-dialled by a numerical keypad button.
- **Button substitution**
the numerical keypad can be used instead of a number pre-stored under a button memory.

Manual Symbols



Safety

- **Always** abide by this information to prevent injury of persons.



Warning

- **Always** abide by this information to prevent damage to the device.



Caution

- **Important information** for system functionality.



Tip

- Useful advice.



Note

- Additional information.

Button numbering – double-button set

			7		15	23		31	39		47
1		4	8		16	24		32	40		48
2		5	9		17	25		33	41		49
3		6	10		18	26		34	42		50
Also applies to keypad sets			11		19	27		35	43		51
			12		20	28		36	44		52
			13		21	29		37	45		53
			14		22	30		38	46		54

Caution

- For the time being, Vandal resistant panels are available only for single-button sets with one extending module at most.
- Installing the info panel name plate, order No. 9135311E, into any of the extending modules will not change the numbering system (the buttons on the info panel sides will remain functional).
- Connecting the info panel module, order No. 9135310E, will result in omission of eight numbers.

- Buttons Labels – Insertion, Replacement
- Electrical Installation
- Camera Installation
- Extending Module Connection

2.1 Before You Start

Product Completeness Check

Please check the contents of your delivery:

- 1 2N[®] Helios unit
- 1 Quick installation guide
- 1 User Manual on a CD
- 1 Hexagonal wrench 2/5
- 1 Transparent name plate foil of size A5
- 1 Spare name plate
- 2 Screws
- 2 Dowels



Note

- If you have bought a complete 'packet', the delivery may contain additional items including instructions for use and lists of available parts.

2.2 Mounting – Mechanical Installation

Overview of Installation Types

An overview of the installation types and the list of the required components are provided in the table below.

Installation type

What you need for installation

Indoor, on surface



2N[®] Helios only

Indoor, flush mounting

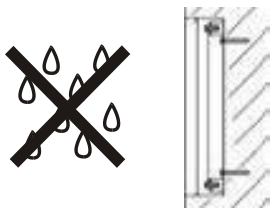

2N[®] Helios

box with 1-module frame **9135351E**

or

box with 2-module frame **9135352E**

Outdoor, on surface

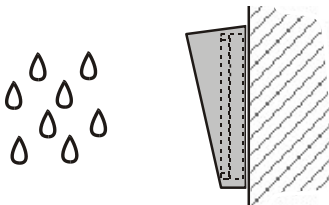

2N[®] Helios

Surface 1-module roof **9135331E**

or

Surface 2-module roof **9135332E**

Outdoor, flush mounting

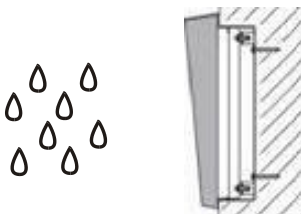

2N[®] Helios

Wall mounting box with 1-module roof **9135361E**

or

Wall mounting box with 2-module roof **9135362E**

With increased resistance

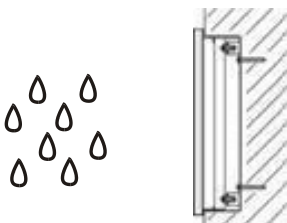

2N[®] Helios

Vandal resistant mask with box, version according to the assembly

Indoor application means:



Indoor areas with a low relative air humidity (e.g., hallways, offices and other heated rooms).

Indoor areas where **humidity condenses** on walls **but never flows down the walls** (porches, storage areas, industrial areas, e.g.).

Outdoor areas where **protection against rain and water flowing down the wall is provided** (sheds, passages, e.g.).

Outdoor application means:



Environments where the product is exposed to rain or where water may flow down the walls (fence, outer wall of a building, e.g.).



Caution

- The warranty shall not apply to product failures and defects caused by improper installation (contrary to these instructions). The manufacturer is neither liable for damages caused by theft within an area that is accessible after the attached electric lock is switched. The product is not designed as a burglar protection device except when used in combination with a standard lock, which has the security function.

Surface Mounting

1. Drill holes using the enclosed **template**. Use the wall dowels attached.
2. With multiple module sets, connect the frames as shown in the figure. Place the basic unit on the left and extender units on the right. The interconnecting cable should be installed later!
3. Put the blanking modules on the unused side holes as shown in the figure.

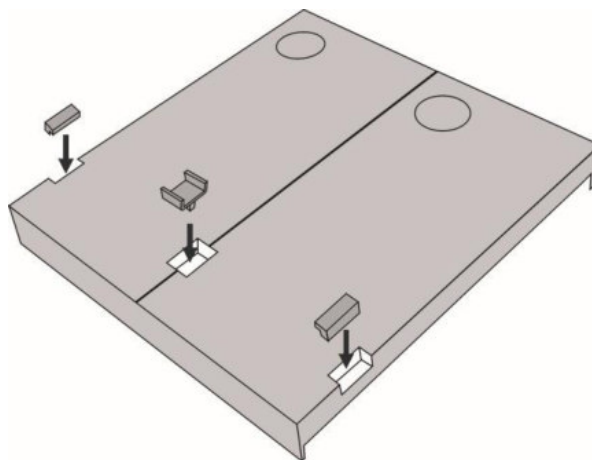

4. If you are utilising a roof module, you should install it now.
5. Screw **2N® Helios** onto the wall. Carry the supply cables (line, lock, power supply) through one of the holes into the basic unit frame.

6. If you use a roof module, fix its upper and side edges to the wall using silicone glue as shown in the figure to the right.

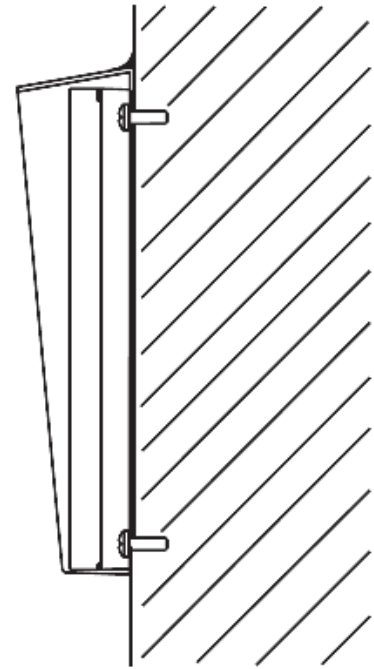

Keep the following outdoor mounting principles:

- Always connect the backlight – it serves to equipment heating.
- Water must not flow in along or around the cables.
- Before closing the cover, carefully check all wires inside the cover for perfect closing.
- Remember to tighten both screws for mounting to wall
- Make sure that all of the three loudspeaker holder feet fit into the board holes. A correct loudspeaker position is necessary for a proper function of the seal.
- Make sure that the silicone seal (tube on the upper face) is in place after installation.
- Remember to tighten all of the four corner screws after electrical installation to make the loudspeaker seal fit perfectly. Otherwise, water might get into the electronic part! Recommended tool: cross-head screw driver PH2.



Caution

- When the above mentioned precautions are not met, water might get in and destroy the electronics. It is because the communicator circuits are under continuous voltage and water infiltration causes an electro-chemical reaction. The manufacturer’s warranty shall be void for products damaged in this way!

Flush Mounting

Use the installation instructions included in the flush mounting box delivery.

Vandal Resistant Mounting

Use the installation instructions included in the Vandal resistant mask delivery.

2.3 Electrical Installation

Compatibility

2N® Helios is designed for conventional, analogue telephone lines and works regardless of polarity and line parameters.(Refer to the Technical Parameters) and uses tone (DTMF) or pulse dialling to be programmed. Normally, it is connected to a PBX line however It can also be connected to an analogue line or the GSM interface providing a wireless installation.

Connection to Telephone Line

Connect **2N® Helios** simply using LINE terminals. The advantage is that **2N® Helios** requires no power supply because all power is fed from the telephone line – except for the button backlight and electric lock, if connected. Nevertheless, **2N® Helios** can work without these circuits too and sends an acoustic signal on having been connected to a line (or after having been disconnected from the line for a defined period of time).

Printed Circuit Board (PCB) Description

Explanatory notes to the figure:

1. Terminal board
2. Left button connector
3. Display connector (for version 10 only)
4. Voice memory
5. One-chip Hands-Free telephone
6. Switch 2 connector
7. Keypad backlight connector
8. Connector for non-standard functions
9. Microphone connector
10. Keypad connector
11. Extension unit connector
12. Serial number
13. Main microprocessor
14. Configuration jumper block
15. Right connector
16. Jumpers
17. Camera connector
18. Camera setting jumpers
19. Loudspeaker connector and panel grounding

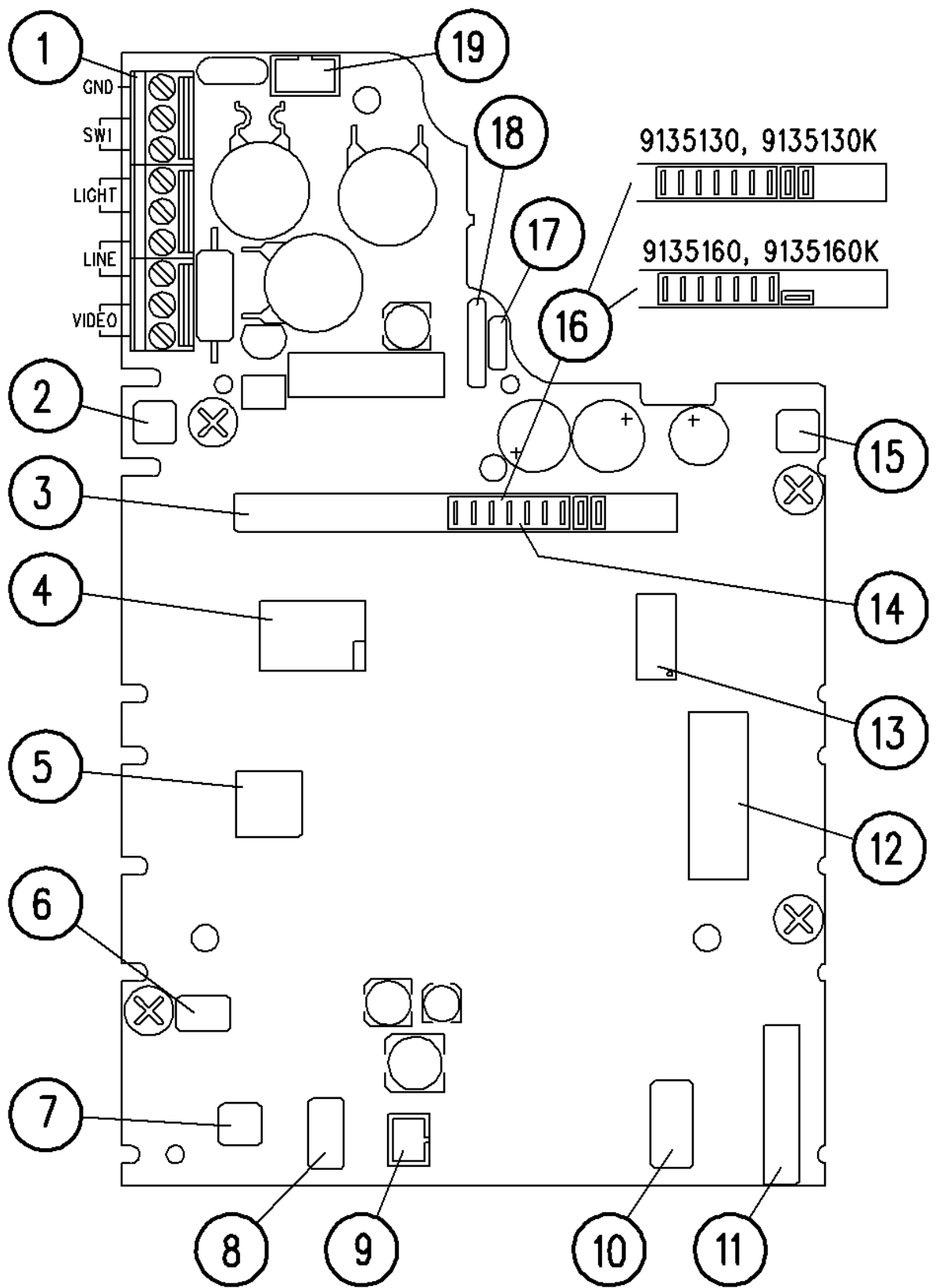

Fig.: PCB Layout, Version 10

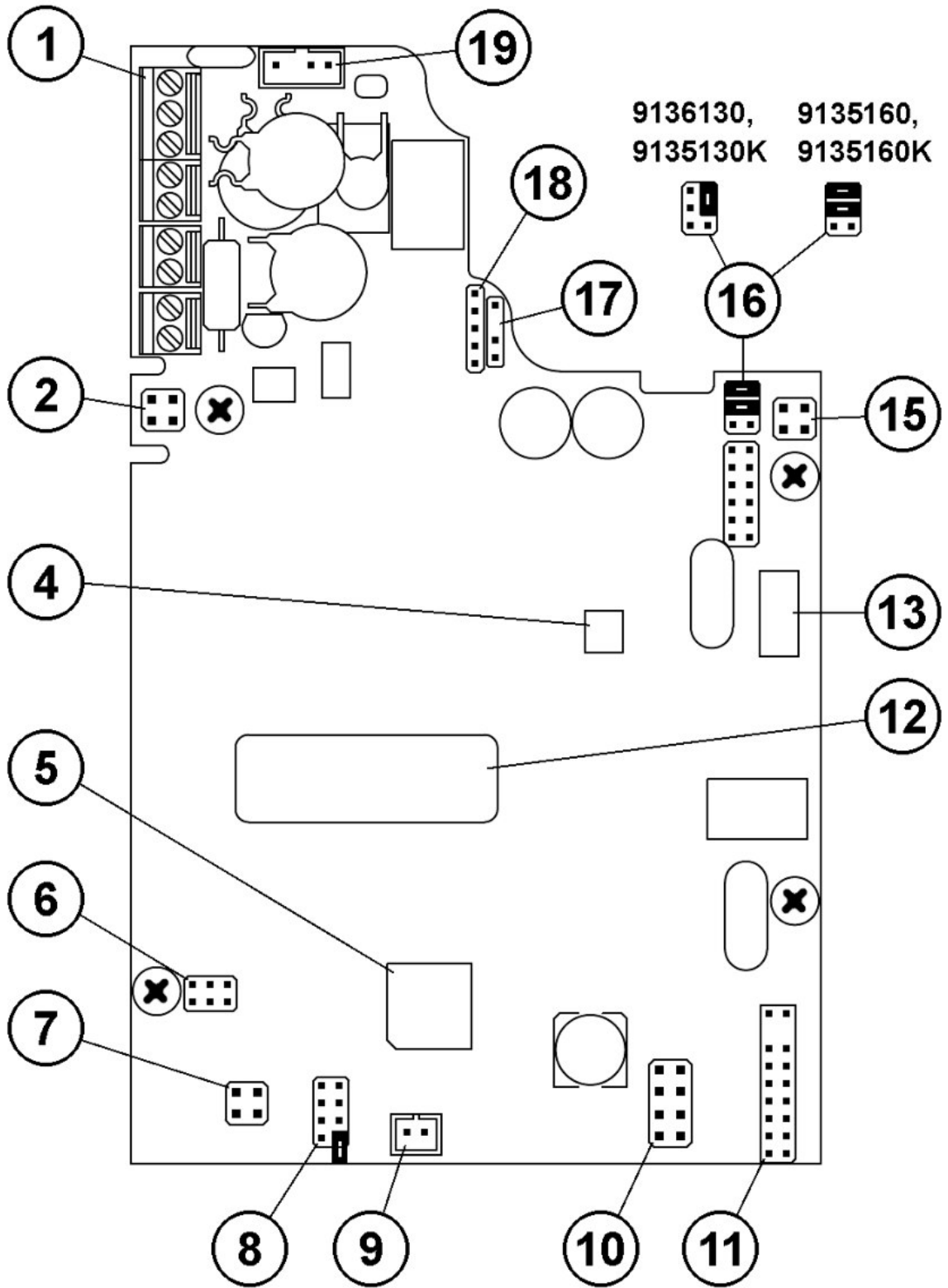

Fig.: PCB Layout, Version 14

Description of Terminals

GND		This terminal protects 2N® Helios against static electricity damage.
SW1		Switch 1 designed primarily for electric door lock control.
LIGHT		These two terminals are connected to the 12V power supply with arbitrary polarity. The power supply can feed the electric lock too.
LINE		These two terminals are connected to the analogue telephone line with any polarity.
VIDEO	-	Video signal output – used only if a camera unit is included. The coaxial cable is connected with an internal conductor to <u>+</u> , with shielding to <u>-</u> .
	+	

Description of Jumpers

Connector (8)



- Here connect the current call indicator (LED).
- Write-protection (if the jumper is mounted).
- do not connect
- **Microphone sensitivity reduction** (mount the jumper for noisy environments).

Camera setting – connector (18): refer to the instructions enclosed to the camera unit.

Parallel Connection

Parallel connection of multiple telephone sets was commonly used in the era in which telephone lines were rare, It carries unnecessary risks to connect the unit in this way. It is in no case recommended to connect **2N® Helios** in parallel to another telephone or another **2N® Helios** door communicator. It is neither admissible to use equipment that switches one line between two or more sets (intelligent double branch, etc.).

Typical Electric Lock Connection

2N® Helios contains a solid-state switch equipped with V-MOS transistors, which is able to switch both ac and dc regardless of polarity. Make sure that the current and voltage values do not exceed limits (refer to the Technical Data) and that the technical parameters of the lock and power supply are compatible.

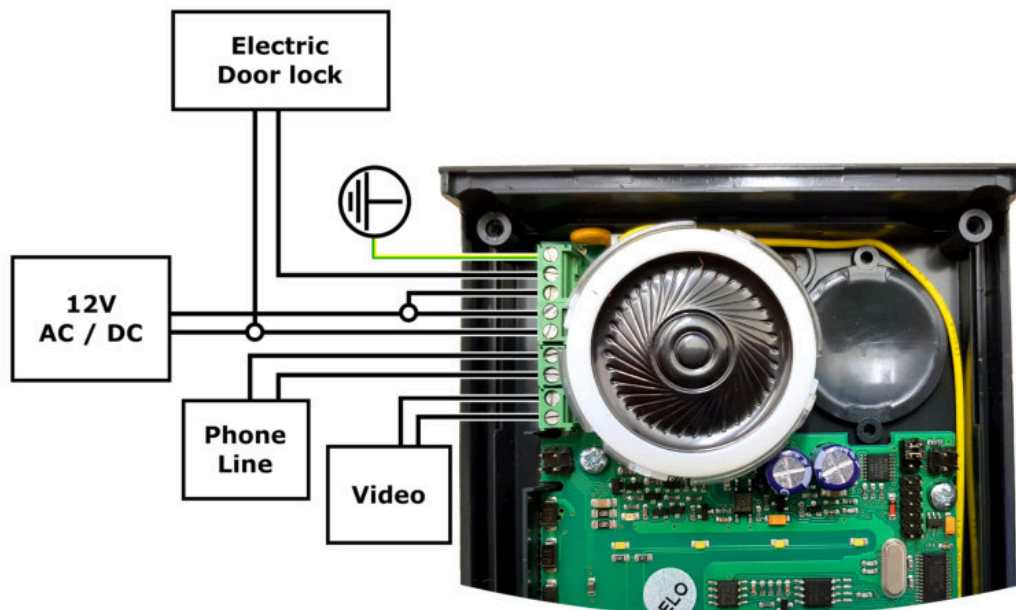

Fig.: Lock Connection



Varování

- Never switch 230 or 120 V mains voltage directly!!!

If you do not have an electric lock and want to have one, you should select a 12 V lock, this being the most common type. Connect the lock according to the figure, which shows the button backlight supply too (see later).

Dc-supplied lock: Practically all locks can be dc and ac supplied. The ac supply is more advantageous because the lock buzzes, which is the clearest signalling method however to use a dc supply lock (from batteries, e.g.), you are recommended to equip **2N® Helios** with acoustic signalling (continuous tone during the whole switch activation time).



Caution

- If the lock power supply fails and the telephone system carries on working, the keypad-equipped 2N® Helios system is unaware of the failure the switch will be password-activated and the activation is acoustically signalled, but the electric lock will not work because of the lack of power.

Typical Backlight Power Supply

2N® Helios features a high-quality white-LED name plate backlight. This backlight shows low power requirements, long life and even illumination of all name plates. If a standard 12 V electric lock (see above) is connected to **2N® Helios**, the backlight can be powered using the lock power supply. Connect the power supply as shown in the figure. Just make sure that the power supply (adapter transformer) is able to supply the required current ***constantly*** and that it is cooled properly (do not wrap it in any thermally insulating material, or use ill-ventilating covers, etc.!). The required current depends on the count of buttons and other elements in the set and can be determined for 12 V according to the following formula:

Basic unit without keypad	80 mA
Basic unit with keypad	200 mA
1 one-side extender unit	80 mA
1 two-side extender unit	100 mA
Camera	130 mA
Reader	150 mA
Display	200 mA

The above mentioned currents are maximum values at 12V.

Cable Arrangement inside the Cover

We recommend you to use a UTP cable (8-wire, approx. 5.5 mm output diameter) for **2N® Helios** connection. Push the cable into the groove on the left side of the cover. If you combine this cable with another one (e.g. the electric lock 2-wire cable), insert the 2-wire first and then the UTP cable to prevent the 2-wire cable from falling out. You can also fit the cables with common clamp tape.



Warning

- An improper cable arrangement may cause a malfunction of the product. Before closing the cover, check all wires and the cover for perfect closing.

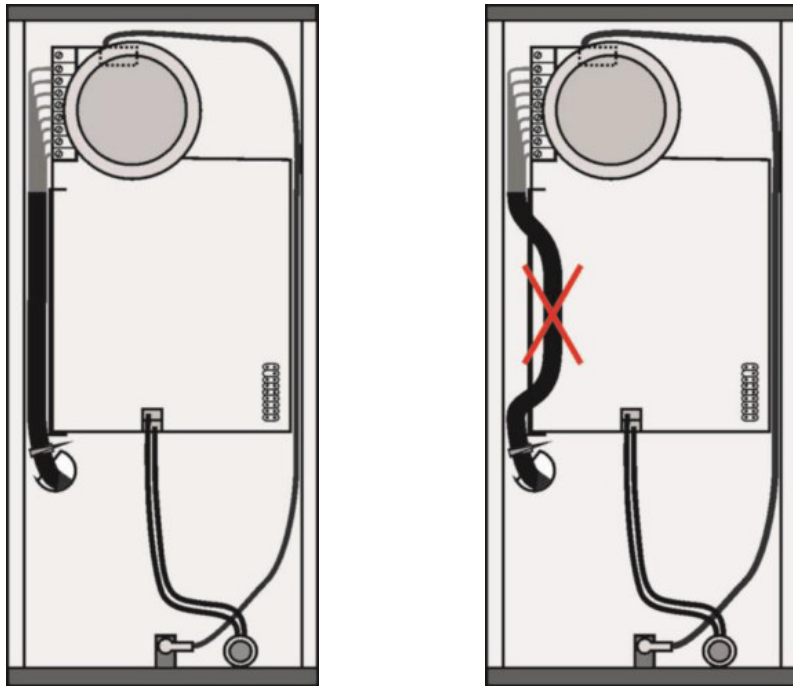

Grounding Terminal Connection - Mandatory

Any person that gets in contact with **2N® Helios** may carry an electrostatic charge of several thousands of Volts. Drawing one's finger near to the **2N® Helios** metal panel may result in spark discharge. The purpose of the grounding terminal is to protect the product against this discharge. The terminal carries the charge from the panel to the ground directly, not through the **2N® Helios** circuits.

Where no grounding cable is available, it is possible to connect the grounding terminal with any of the telephone line terminals*). In some telephone systems one line terminal is directly connected with the ground, the others carry current to the ground through overvoltage protection.



Note

- This connection eliminates direct connection of the line conductor onto the panel because there is a protective element between the panel and the grounding terminal.

Separate Backlight and Electric Lock Supply

Separate power supplies are necessary where the lock requires voltage higher than 12 V. In this case, an additional power supply (12V) must be used to illuminate the button backlight - see the figure below. Other reasons for such connection are the effort to minimise consumption from the back-up supply (which supplies the lock, not the backlight), or just that two weaker power supplies are available

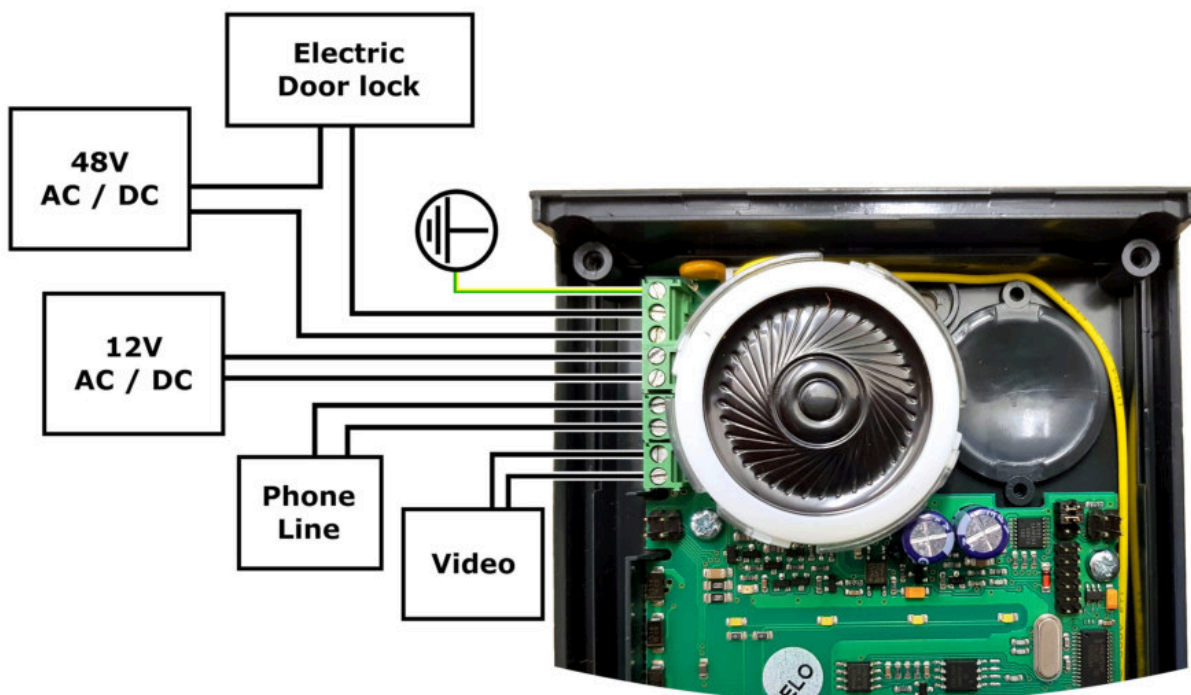

Lock and Backlight Connection

Connection of Switch 2

A new additional switch, Part No. 9135250E, has been designed for **2N® Helios**. It can be mounted into any basic unit, as an added option. To connect it, follow the instructions included in the switch delivery.

2.4 Camera Installation

The camera unit, Part No. 9135210E, can be built into any **2N® Helios** basic unit during installation or as an option to be added later. You can also use the camera unit in combination with any Vandal resistant panel. It is a colour CCD camera with high resolution of 420 TV rows, with a monochrome night mode (infrared backlight hidden under the nameplates), and has a wide-angle pin-hole lens (90° diagonally) and a tilting hinge for manual direction adjustment.

The camera has a PAL composite output and can be connected to any TV display (e.g. Part No. 9134147 - 7" TFT LCD), or a video server (Part No. 9134137, MPEG4 LAN video server). A coaxial or twisted cable can be used for connection.

A sight glass is included in the delivery, which replaces the non-transparent **2N® Helios** basic unit sight glass imitation. To install the camera, follow the instructions that come with it.



Warning

- To install the camera, use the stabilised 12 V dc power supply. To get a suitable (12V / 2A) one, order Part No. 91341481E.

2.5 Extending Module Connection

2N[®] Helios features an easy installation of extending button modules. Extending modules are connected using a single cable (included in every extender delivery) in a chain pattern (every additional unit is connected with the previous one). Each extending module has two connectors – an input connector (for connection towards the 2N[®] Helios basic unit) and an output connector (for connection of another, more remote unit). Be sure to maintain the correct orientation of the units and avoid connector mismatch to ensure a proper function of the device!

Module Cable Interconnection

- The cable is included in every extending module delivery. Both its ends are the same. Configuration is 1:1. Connectors cannot be shifted or inserted conversely because they are equipped with a so-called key.
- The basic unit is always on the left. Extenders are chain-connected, i.e. each is linked with its neighbour.
- The cable cannot be driven through the box interconnecting holes until the boxes have been connected (see subsection 2.3 Mounting – Mechanical Installation).

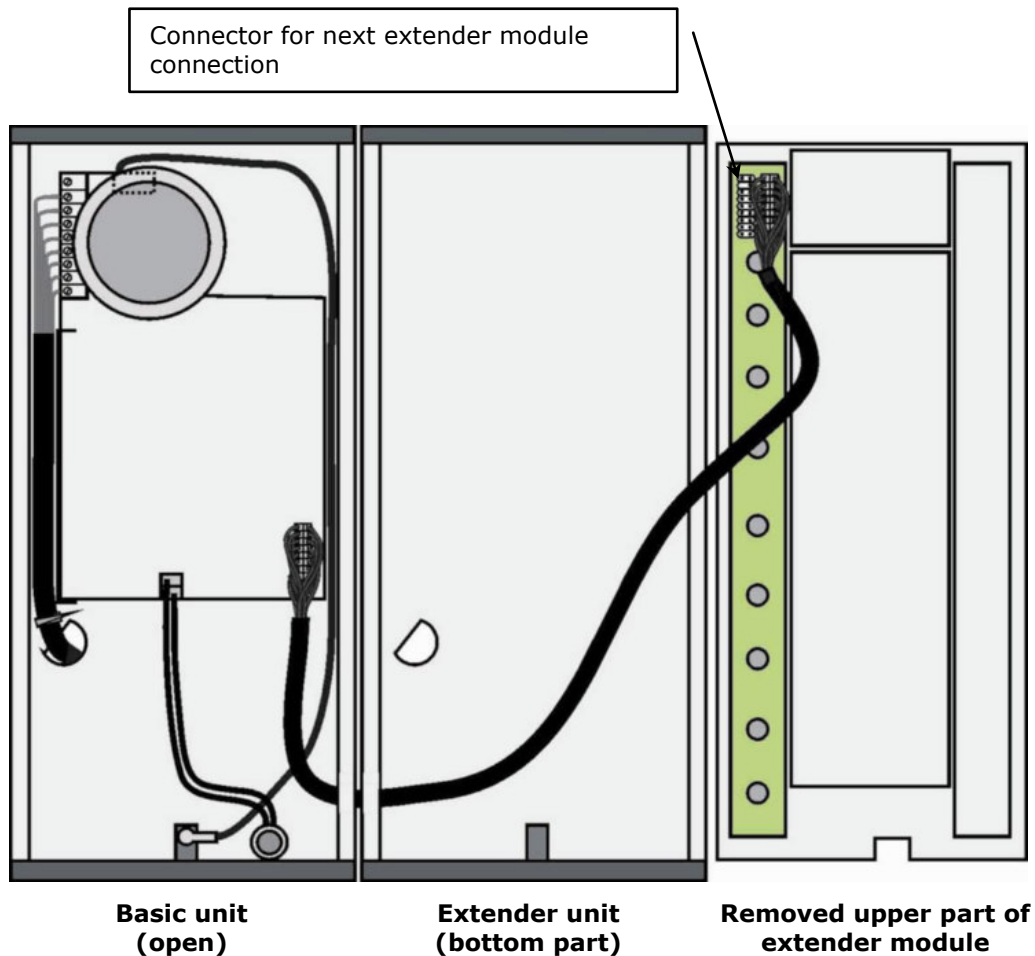

Fig.: 8-Button Extender Module Connection to Basic Unit

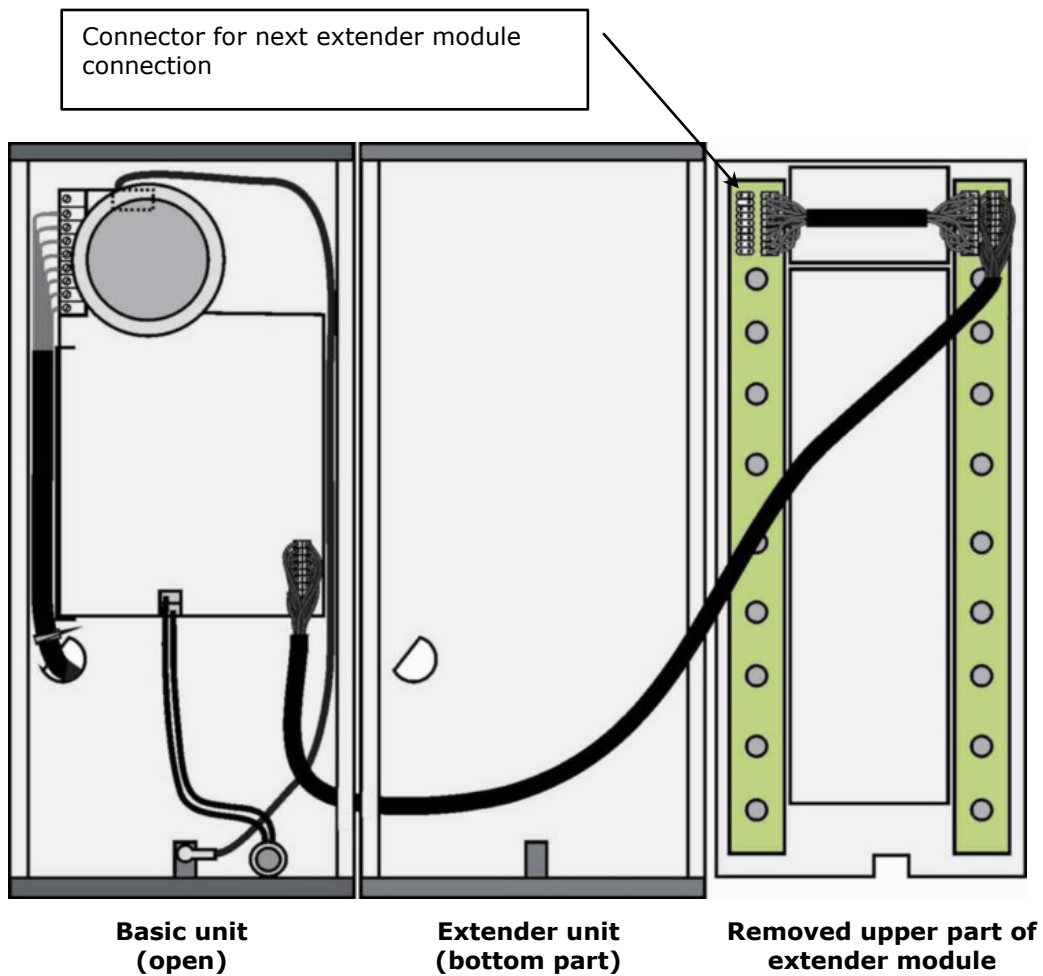

Fig.: 16-Button Extender Module Connection to Basic Unit



Caution

- Extension modules must be interconnected by mounting jumper (tunnel), delivered together with each extension unit. This part is made from conductive plastic. If it is necessary to place extender unit at some distance, or if you lost the jumper, you must interconnect metallic covers by another way.

Maximum Count of Extenders

9135181E (1×8 buttons)	6	5	4	3	2	1	0
9135182E (2×8 buttons)	0	0	1	1	2	2	3

The table above shows how to combine modules with single (whole) and double buttons.

Button Numbering

Button numbering – whole-button sets

<table border="1"> <tr><td></td><td>1</td></tr> <tr><td></td><td>2</td></tr> <tr><td></td><td>3</td></tr> </table>			1		2		3	<table border="1"> <tr><td></td><td>7</td></tr> <tr><td></td><td>8</td></tr> <tr><td></td><td>9</td></tr> <tr><td></td><td>10</td></tr> </table>			7		8		9		10	<table border="1"> <tr><td></td><td>15</td></tr> <tr><td></td><td>16</td></tr> <tr><td></td><td>17</td></tr> <tr><td></td><td>18</td></tr> </table>			15		16		17		18	<table border="1"> <tr><td></td><td>23</td></tr> <tr><td></td><td>24</td></tr> <tr><td></td><td>25</td></tr> <tr><td></td><td>26</td></tr> </table>			23		24		25		26
			1																																		
			2																																		
			3																																		
	7																																				
	8																																				
	9																																				
	10																																				
	15																																				
	16																																				
	17																																				
	18																																				
	23																																				
	24																																				
	25																																				
	26																																				
<p>Also applies to keypad sets</p>		<table border="1"> <tr><td></td><td>11</td></tr> <tr><td></td><td>12</td></tr> <tr><td></td><td>13</td></tr> <tr><td></td><td>14</td></tr> </table>			11		12		13		14	<table border="1"> <tr><td></td><td>19</td></tr> <tr><td></td><td>20</td></tr> <tr><td></td><td>21</td></tr> <tr><td></td><td>22</td></tr> </table>			19		20		21		22	<table border="1"> <tr><td></td><td>27</td></tr> <tr><td></td><td>28</td></tr> <tr><td></td><td>29</td></tr> <tr><td></td><td>30</td></tr> </table>			27		28		29		30						
			11																																		
			12																																		
			13																																		
	14																																				
	19																																				
	20																																				
	21																																				
	22																																				
	27																																				
	28																																				
	29																																				
	30																																				

It is possible to continue to 54

Button numbering – double-button set

			7		15	23		31	39		47
1		4	8		16	24		32	40		48
2		5	9		17	25		33	41		49
3		6	10		18	26		34	42		50
<p>Also applies to keypad sets</p>			11		19	27		35	43		51
			12		20	28		36	44		52
			13		21	29		37	45		53
			14		22	30		38	46		54



Caution

- For the time being, Vandal resistant panels are available only for single-button sets with one extending module at most.
- Installing the info panel name plate, order No. 9135311E, into any of the extending modules will not change the numbering system (the buttons on the info panel sides will remain functional).
- Connecting the info panel module, order No. 9135310E, will result in omission of eight numbers.

2.6 Buttons Labels – Insertion, Replacement

Instructions

1. Remove the **2N® Helios** metal cover. To do this, use a hexagonal key, unscrew the screw as shown in the figure and take the cover off.

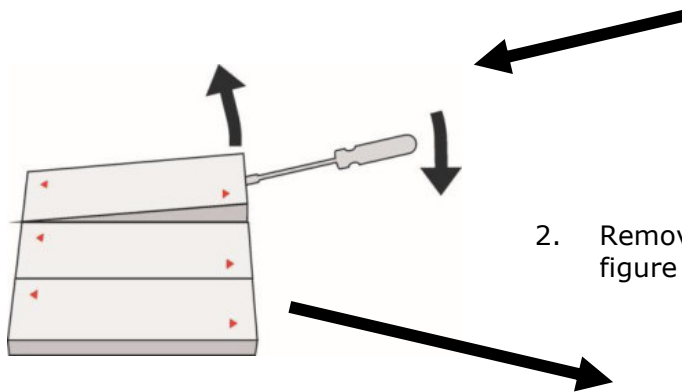
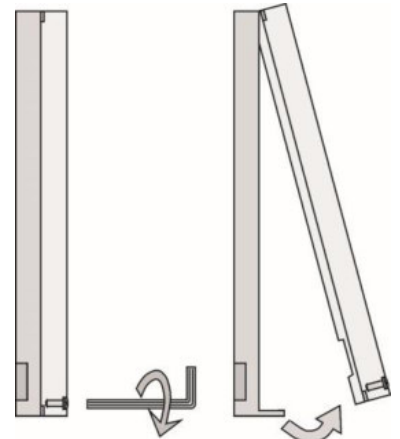

2. Remove the name plates as shown in the figure using, e.g., a screw driver.

3. Remove the name plate inserts as shown in the figure.

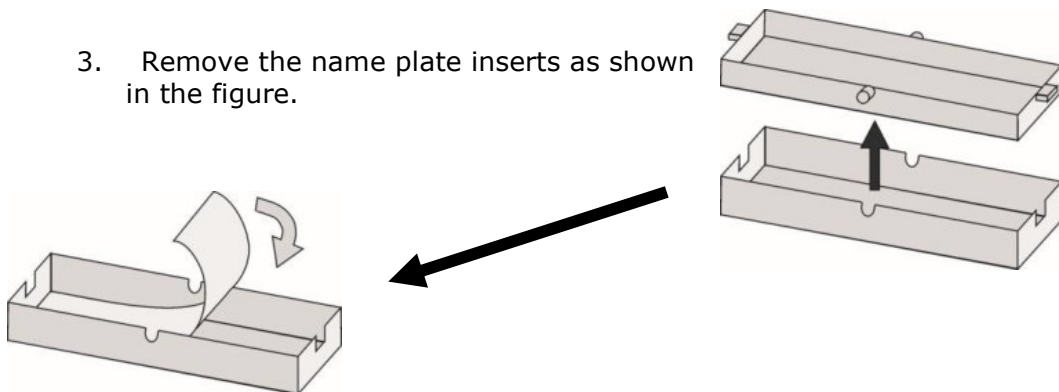

4. Insert the labels printed on foil (see later).
5. Replace the name plate inserts.
6. Put the name plates back in the depression and click into position. The name plates keep the matt foil steady.
7. Replace and screw on the metal cover.



Note

- You can remove the name plates even without removing the metal cover however damage, if any, incurred as result of this, is not covered by the warranty.

Label Material and Printing

Every **2N® Helios** delivery includes a sheet of transparent foil that can be easily printed, with a laser printer. Cut the printed foil into pieces and insert the labels into the name plates. Do not use paper to avoid water logging.

Make sure that the text does not cover up the red arrows printed on the name plate, we recommend you to print the foil using a template (MS Word), available at www.2n.cz in section "Downloads", direct link: [Template - name tags](#)

Single surface button

Name 01
Name 02
Name 03

Horizontally split button

Name 01	Name 04
Name 02	Name 05
Name 03	Name 06

2.7 Mounting - Completion

1. Remember to seal the 2N[®] Helios IP cable passage hole properly to avoid moisture in-leak and damage to electronics due to condensation.
2. Make sure that the wires inside 2N[®] Helios IP are not squeezed and insert the plastic top cover (a transparent plastic mould) carefully making its contacts plug into the electronics board connectors. Push the plastic cover into position moderately. If the part swings over an obstacle or one corner is higher than the others, remove the cover and find the obstacle. Then tighten the corner screws properly.
3. Mounting the metal cover follow the steps included in the subsection dedicated to name plate removal. Make sure that the cover fits well and is perfectly flat. If its bottom part is loose, the mounting wall is probably uneven. Support the corners to avoid 2N[®] Helios IP bending.



Caution

- An improper mounting may significantly deteriorate the button function.
- A poor outdoor mounting may cause water in-leak and damage to the electronics.

Most Frequent Mounting Errors

For illustration, a part of the plastic cover is removed in the figures below to reveal the sealed loudspeaker and the cover–seal touch point. The cross section plane is marked white for better orientation.

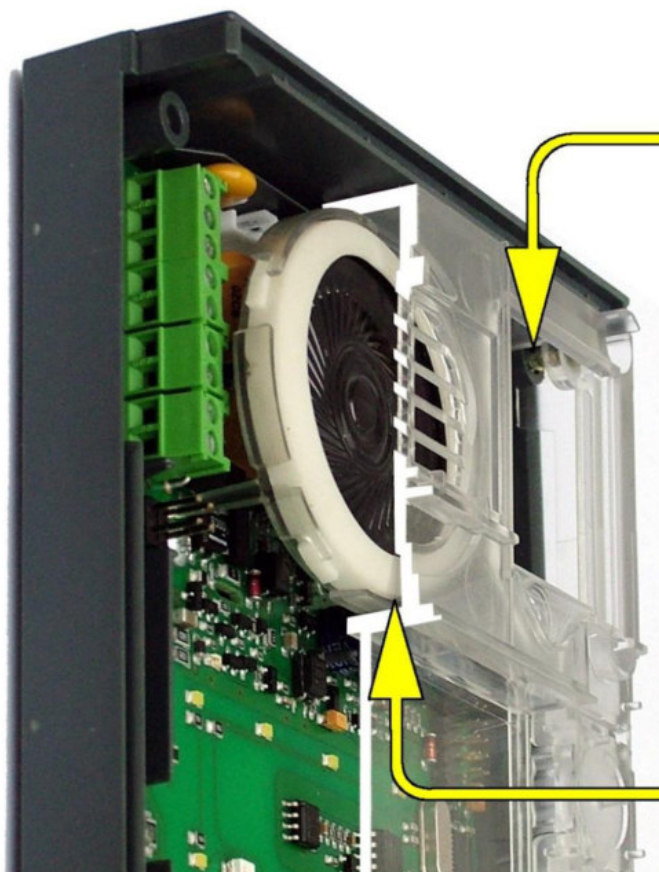

Poorly tightened screw
(a squeezed wire has the same effect)

WRONG

Gap between plastic cover and loudspeaker seal
- water may leak in and damage electronics

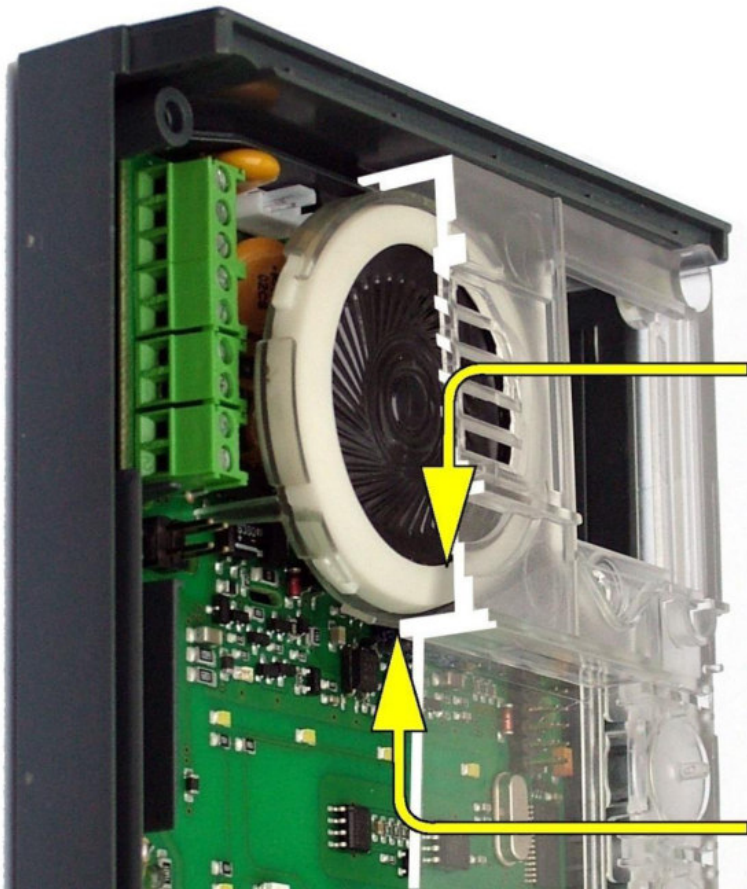

WRONG

Gap between plastic cover and loudspeaker seal
- water may leak in and damage electronics

If the loudspeaker support is in a wrong position, the plastic cover may catch the support brim (see the arrow) and, if treated roughly, lead to component deformations. Leakage may arise, see the upper arrow.

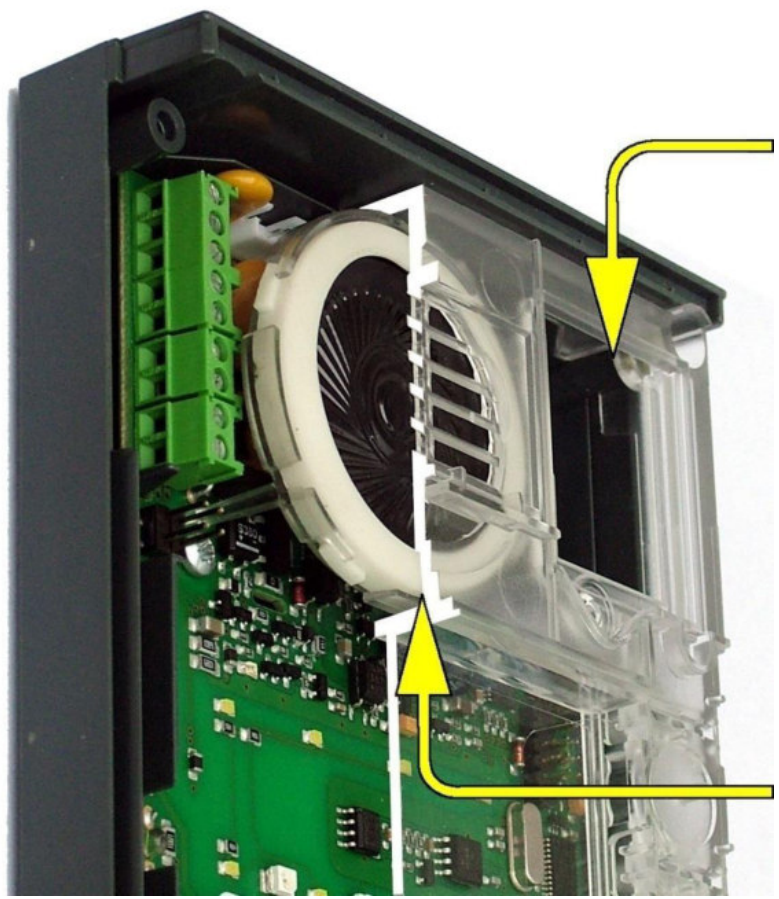

Properly tightened screw

RIGHT

The seal touches the plastic cover. Water flows out through a small hole (not shown in the figure).

Note: Water does not affect the loudspeaker Mylar membrane.

3

2N[®] Helios Configuration

This section describes the 2N[®] Helios configuration.

Here is what you can find in the section:

- Programming
- Full Parameter Chart

3.1 Programming

All **2N® Helios** parameters, including the keypad ones, are set remotely using any tone-dialling telephone set (or a mobile phone). First call **2N® Helios** and enter the programming mode. The access to this mode is service password protected.

A voice menu is available in the programming mode and so you need not use this manual to program standard parameters. The menu is stored in the **2N® Helios** memory in the default language. Having entered the full parameter or memory number, you can hear how the parameter has been programmed, thus checking the programmed numbers for correctness.

All parameters are stored safely in the non-volatile EEPROM memory. The memory capacity does not limit the count or length of numbers, passwords, etc. This means that altogether 324 memories for 16-digit telephone numbers, 54 Arrival/Departure password memories, 20 switch password memories, etc. are available.



Tip – Before You Start Programming

- Write or print the values to be programmed to minimise the risk of error. Moreover, this gives you an idea of what you have programmed. Make sure that programming is not barred (JP1 jumper) – refer to the PCB Description subsection.

Entering Programming Mode

You can enter the programming mode only during an incoming call (telephone – **2N® Helios** call). The programming barring jumper must not be mounted. To get into the programming mode, enter the service password in the format ***password*** (do not forget to enter the asterisks before and behind the password!). The service password is 12345 by default and can be changed ,. If you enter the password correctly, the voice menu is launched. Now you can start programming.

Programming Procedure

You can set parameters in any order and as many times as you wish. To change a parameter use the following command:

Parameter number * parameter value *

A three-digit **parameter number** is assigned to every parameter to be programmed and to every memory (refer to the Programming Chart). This number indicates to **2N® Helios** which parameter to change, and ***** is used as "Enter". When it is entered, **2N® Helios** repeats the parameter (or memory) number and reads the current contents (excluding passwords). Now you can enter new data – of variable meaning and length depending on the parameter selected (refer to the Full Parameter Chart). Finally, press ***** again for confirmation. **2N® Helios** confirms the data saving. Repeat this procedure for each parameter.

Switch Password Programming

Each switch can be controlled with up to 10 different passwords that are listed in the **2N® Helios** memory. Passwords can be added to the list using functions 811 and 821 and deleted with functions 812 and 822 individually. The default status is a single password in the list, namely **00** for switch 1 and **11** for switch 2. These two special passwords cannot be entered from the **2N® Helios** keypad. To cancel them, you have to remove them from the list:

8 1 2 * 0 0 * or 8 2 2 * 1 1 *

Function 997 deletes the entire password list for both switches including the passwords 00 and 11. Function 999 deletes the entire password list for both switches too but recovers the passwords 00 and 11 and the service password 12345.

Password Selection Restrictions

Controlling the switches by phone, you can enter the password without any starting and terminating characters and the password length is not limited. **2N® Helios** has to verify after every character received whether the password is complete or not.

Therefore: **make sure that no password is identical with the beginning of another password.**

- Should you use such confusing passwords for switch control, you have to enter the longer password (by phone) with asterisks at the beginning and end.
- If **2N® Helios** refuses to store a password, it means that the switch password list is full, or the password has already been entered.
- The switch password may not be identical with any Arrival/Departure, Day/Night, or service password.
- For password selection tips see the Instructions for Keypad Use.

Programming Error

- Any wrong value can be re-programmed by another command (immediately or any time later).
- If you make a typing error, cancel the entered value with [#]. Then you can re-enter the whole number.
- If you enter an incorrect parameter number or parameter value, **2N® Helios** sends a refusal signal and you have to start with the parameter number again.
- If you do not press any button within a predefined timeout, **2N® Helios** sends a hang-up signal and hangs up. The timeout is 5 seconds; every [*] character is followed by 30 seconds for you to think over your setting. The 5-second limit starts when **2N® Helios** has read all that relates to the current user position in the programming menu. The timeout can be prolonged – see the chart.

**Tip**

- **To check programmed values:** enter parameter number and **[X]**, listen the parameter value and press **[#]** for return to the main menu.

Deleting All Passwords, All Memories, Complete Initialisation

The following three functions facilitate your programming by clearing all previous settings:

- **997**
deletes the entire password list for both switches including passwords 00 and 11.
- **998**
deletes memories of all buttons (01 - 54) plus Arrival/Departure and Day/Night passwords.
- **999**
clears the whole memory and resets the default values (see the chart).

Protection against Unintentional Deletion

The above functions need no special "value" but must be protected against unintentional initiation. Therefore, enter the service password as the value. Warning: Full initialisation takes a few seconds, 2N® Helios sends a continuous tone while memory clearing. Functions 997 and 998 take a little less time and are signalled by a continuous tone too.

The button memories can be deleted individually too – just enter a "blank" while programming. For example: **[0] [1] [1] [X] [X]** clears memory 1 of button 01.

If You Forget the Service Password

If you forget the service password, contact the manufacturer. The manufacturer can change your service password to 12345 remotely without altering any other parameter.

3.2 Full Parameter Chart

Parameter (function)	Parameter Name	Range	Default	Note
011 to 546	All button memories	Up to 16 digits	blank	
Digits 0-9 can only be entered directly into the memories. Special characters are entered additionally using function XX7 :				
017 to 547	Enter special chars (X), (#) and pause			<p>Entering format:</p> <p>1 = (X) 2 = (#) 3 = space</p> <p>Note: The digits behind this position are shifted automatically.</p>
018 to 548	Count of automatic dialling cycles	0-9	0 = off	
019 to 549	Arrival/Departure password	up to 16 digits	blank	
559	Day/Night password	up to 16 digits	blank	The same as for Arrival/ Departure, identical for all buttons
811	Enter up to 10 switch 1 passwords	up to 16 digits	00	Passwords 00 and 11 cannot be entered from the keypad! Up to 10 switch passwords Delete passwords using functions 812, 822
821	Enter up to 10 switch 2 passwords		11	
812	Delete valid switch 1 passwords	Valid password		Deletes individual valid switch 1 passwords.
822	Delete valid switch 2 passwords		Deletes individual valid switch 2 passwords.	
813	Switch 1 closing time	0-9 s	5s	0 = switch disabled
823	Switch 2 closing time	0-9 s	5s	0 = switch disabled
824	Switch 2 delay	0-25 s	0	0 = switch 2 is not synchronised with switch 1

Parameter (function)	Parameter Name	Range	Default	Note
901	Dialling type	0-1	0 = tone	1=pulse 40/60
902	Dialling timeout after pick-up	5-99	8 = 0.8s	Range of 0.5 - 9.9s
903	DTMF level	0-12	6	1 step = 1 dB
904	Automatic Multiple Number Dialling type	0-3	0 = disabled for all buttons	1 = loud with confirmation 2 = silent with confirmation 3 = SP without confirmation ¹⁾ 4 = SP without confirmation ¹⁾
906	Ticking into call	0-12	0 = off	The called party recognises better that the incoming call is from 2N® Helios.
911	Count of rings before incoming call answering	1-99	2 	Warning!!! No connection is established if a higher value is entered than as allowed in the PBX ringing timeout!!!
912	Max. call duration	1-99	12 = 120s	Range of 10s-990s
913	Log-in timeout	1-99	3	3 = 30 seconds
915	Hang-up time between calls	5-99	15 = 1.5 s	
921	Code lock mode	0-1	1 = enabled	0 = disabled 1 = enabled For details on these functions see the Keypad Description.
922	Buttons replaced by keypad	0-1	0 = disabled	
923	Telephone mode	0-1	0 = disabled	
924	Tone dialling during call	0-1	0 = disabled	
931	Microphone power-up level	0-3	2	0 = Maximum microphone sensitivity
932	Automatic response speed	0-3	2	3 = Maximum response speed
933	Reception volume	0-15	7	15 = Maximum reception volume
934	Transmission volume	0-15	7	15 = Maximum transmission volume
935	Message volume	0-15	7	15 = Maximum message volume
936	Beeping volume	0-12	12	12 = Maximum tone volume
937	DTMF hearing (side tone) volume	0-3	3	3 = Maximum DTMF volume
938	Loudspeaker volume	0-15	7	15 = Maximum loudspeaker volume

941	Minimum continuous tone time	10 - 99	20 = 2s	If the tone is longer, 2N® Helios hangs up.
942	Minimum busy tone or pause duration	0-255	8 = 0.08s	These parameters control the busy tone detection. They are used for call termination and automatic dialling.
943	Maximum busy tone or pause duration	0-255	70 = 0.7s	
944	Maximum tone-pause difference	0-255	10 = 0.1s	
945	Minimum count of busy tone periods	2-9	4	
946	Dual tone detection setting	0 - 10	4 = 440 Hz	All continuous, busy and ringing tones are detected. Dual tones are detected if one of their components is between 400 and 500 Hz. If both components are in this range, set a lower detection value. Set 0 for 400 Hz and 10 for 500 Hz. <i>This setting does not affect the single tone detection, which always works between 300 and 550 Hz.</i>
951	Minimum ringing tone time	1 - 200	50 = 0,5 s ²)	The longest ringing period pause must be in the interval between parameters 952 and 953.  Warning! As these parameters also detect incoming calls, an incorrect setting may result in 2N® Helios not answering the call!
952	Minimum long pause time	5 - 100	10 = 1 s	
953	Maximum long pause time	10 - 100	60 = 6 s	
954	Count of ringing periods	1 - 99	10	If the preset count of periods is exceeded, the call is terminated.
	If the preset count of periods is exceeded and automatic dialling is enabled, another attempt follows. In the event of Automatic Dialling <u>without Confirmation</u> , the ringing tone is recognised and ends before the preset count of periods is exhausted; the call is regarded as successful.			
961	Maximum timeout for pressing the next digit	1-9	5 s	During password entering, etc.
963	Possibility to hang up by pressing the same button	0 = no 1 = yes	1	
964	Possibility to dial the next number by pressing another button	0 = no 1 = yes	1	
965	Possibility to hang up by pressing #	0 = no	1	

	(DTMF)	1 = yes		
971	Count of message repetitions	0 - 9	3	There is a 3-second pause between every two messages.
974	Communicator identification number	16 digits	-	The number enables communicator identification.
975	Message options for automatic multiple number dialling	2 digits	55	1st digit = type of message repeated after dialling. 2nd digit = type of message after confirmation. The following digits are used: 2 = identification (974) - loud speaking 4 = identification (974) - DTMF 5 = message as defined in par. 977 (after confirmation by par. 976) 7 = confirming tone (after confirmation only)
976	language selection for a message	0 - 8	1	0 = 🎵 1 = English 2 - 3 = 🎵 4 = German 5 - 7 = 🎵 8 = Portuguese 9 = Dutch 10 ... 99 = silence
977	language selection for "wait, please" message	0 - 8	1	Note: See Survey of messages in Subs. 4.2 Caution! Czech version has language order: 1 = Czech, 2 = English
991	Service password		12345	12345 by default
995	Software version identification	-		This function reads out the current software version. Format: year-month-day. Writing disable.
997	Deletion of passwords of all switches	Service password	12345	Deletes passwords 00 and 11 too.
998	Clearing of all memories		12345	Clears memories 01 to 55.
999	Full initialisation		12345	Warning! Changes the service password too (setting the default value of 12345).



Notes

- Terminology: For the purpose hereof, **parameter** means a **value** that is stored in the 2N® Helios memory and can be re-programmed. **Function** is a means of execution of another service such as initialisation, software version identification and so on.
- ¹⁾ Types 3 and 4 of Automatic Dialling without Confirmation differ from each other in how they process very short calls (a few seconds). Dialling type 4 regards a call as successful in all cases, type 3 only if the door was opened.

Explanation of Some Parameters

824 - Second Switch Synchronisation

Set the parameter to a non-zero value to make switch 2 activate automatically with a defined delay if switch 1 is activated. Useful where two doors are close to each other.

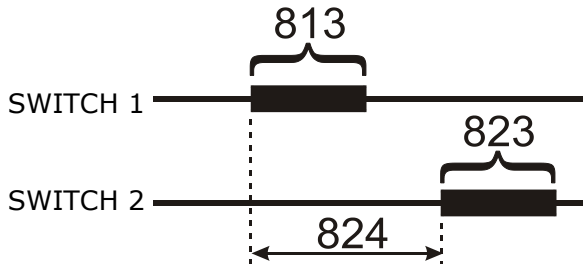

(The numbers in the figure are parameter numbers.)

The parameters can be set to overlap activation of the two switches:

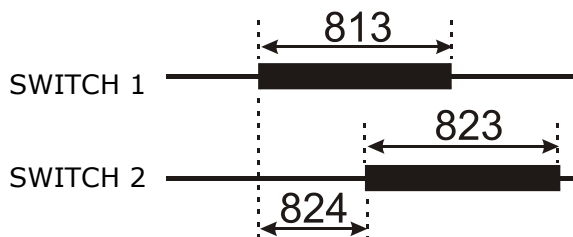

Explanation of Parameters 951, 952, 953

Ringling tone (example)

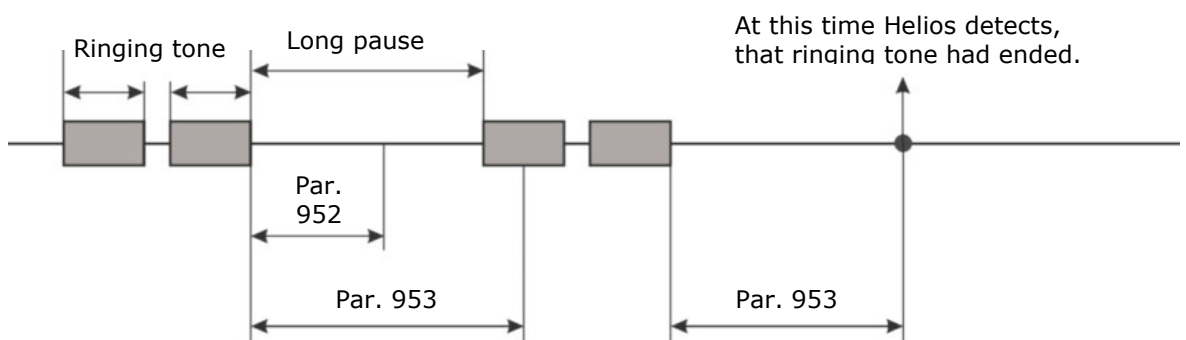

Explanation of Parameters 942, 943, 944

Busy tone

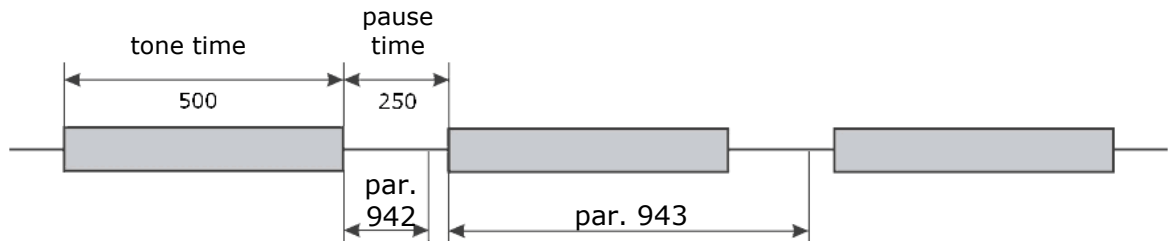

Example:

The busy tone in the figure above is considerably longer than the pause time. Therefore, set parameter **942** according to the pause, to 200 ms, e.g., and parameter **943** according to the tone, to 600 ms, for example. In this case, however, the default values can be maintained for both the parameters. Since the tone – pause difference is $500 - 250 = 250$ ms, **set parameter 944** to 300 ms, for example.



Note

- Increase parameter 944 also when 2N® Helios is placed in a hall or corridor with a large decay time.

4

Function and Use

This section describes the basic and extending functions of the product.

Here is what you can find in the section:

- Function Description
- Section for Advanced Users
- Maintenance

4.1 Function Description

From External User's View (Visitor)

Like normal Doorbells, **2N® Helios** buttons are provided with labels the visitor finds the appropriate button (e.g. Mr. Smith) and presses it this activates **2N® Helios** to then dial the number pre-programmed for under that button, the visitor can then hear the ringing tone from the loudspeaker and the required (Mr. Smith's in this case) telephone is ringing. If the **2N® Helios** unit is connected to a telephone system you may be able to tag the port that **2N® Helios** is connected to so that you can see on the ringing phone that it is **2N® Helios** that is calling. When the called party answers the call, the visitor and tenant can speak to each other and If an electric lock is connected to **2N® Helios**, the called person can open the door by entering the correct password on the telephone keypad to activate the door or barrier. When the caller hangs up, **2N® Helios** detects the PBX or analogue line tone and hangs up too. **2N® Helios** also hangs up when it "hears" the busy tone or if the call takes more time than pre-programmed to connect. You can pre-program the amount of time that you have to speak into the microphone however when you are reaching the programmed time the unit gives a warning tone 10 seconds before hanging up so that the called party can extend the call if required.



Note

- If the visitor presses another button during the call, **2N® Helios** hangs up for a few seconds before dialling the new number.
- If a button is pressed that has no number stored within it **2N® Helios** picks up the line, sends a refusal tone (refer to the Signals Overview) and hangs up.
- If the visitor presses the same button during the call, **2N® Helios** may hang up (can be programmed to stop this feature if required).
- The above mentioned rules are only applied if the Automatic Multiple Number Dialling mode is OFF. For this special mode refer to the Automatic Multiple Number Dialling section.

Function Description – Numerical Keypad Models

The **2ENTRY® Helios** basic units, Part Nos. **9135130K** and **9135160K**, are equipped with a numerical keypad. The keypad provides a number of functions:

- traditional code lock
- features as if a normal telephone set
- DTMF transmission during an outgoing call
- substitution of up to 54 buttons

The keypad features a smart metal design and very favourable price to performance ratio. For the description of the functions from the user's view see below.

From Internal User's View (Survey of Functions)

Calling to 2N® Helios

You call the appropriate extension and **2N® Helios** makes the call and gives a confirmation tone after two rings (or as pre-programmed). Now you can speak and control the 2 switches, program **2N® Helios** (see later), and listen to what is going on outside and speak to the calling party if desired.

Door opening

2N® Helios contains a switch to which an electric lock can be connected (not included in this pack). This switch can be telephone keypad controlled using a (digital) password in two ways as shown in the default password 00 example below:

0 0

or

* 0 0 *

The switch activation time can be programmed once the switch is enabled this will also automatically terminate the call in the next 30 seconds.



Note

- If the Automatic Multiple Number Dialling with Confirmation or the Silent Automatic Multiple Number Dialling with Confirmation mode is selected and the password starts with digits 1 to 5, an asterisk must always be used.
- **You Must** enter every digit in the password within five seconds (or as pre-programmed) to avoid **2N® Helios** from hanging up.

Switch 2 activation (light, e.g.)

The second switch (if an additional switch is installed) can be controlled in the same way.

Switch 2 synchronisation

Switch 2 can also be used to delay the opening of another door. Once the switch 2 delay timeout is programmed, the second switch is synchronised automatically with the first one, the delay being 1 – 25 seconds.

Switch activation signalling (for both switches)

After the correct password is entered, the switch is activated and you can hear the confirmation signal on your telephone. You can now speak (e.g. say: "The door is open") or listen (to the door-opening sound, etc.) until the switch is deactivated. Upon deactivation, you can hear the storing signal (see the Signals Overview).

Call extension

2N® Helios beeps 10 seconds before the call end to extend the call by 30 seconds press  on your telephone (DTMF). You can use this function repeatedly. The visitor, however, cannot use this function!

Programming





The access to this mode is password-protected. For details refer to the Programming section. The voice menu considerably helps with programming 2N® Helios. Having entered the programming mode, you can also alter any parameter and memory settings.



Caution

- The above mentioned functions (except for calls to **2N® Helios**) require a **tone-dialling** telephone set.

Signals Overview

Signal	Name	Meaning
	Confirmation	sent immediately after line seizure for incoming calls (can be heard by the calling party); signals switch activation (by DTMF) - can be heard by the person "at the other end" who activated the switch
	Refusal	signals that a non-programmed button has been pressed; signals that an incorrect password has been entered on the keypad; can be heard from the loudspeaker after line connection (first connection signalling); signals an incoming call if 2N® Helios has not been programmed; When a disabled function has been entered from the keypad.
	Storing	Signals switch deactivation (if activated by DTMF).
	Hang-up	Sent to notify that the call is terminated (in all cases).
Long continuous tone		signals that the unit is going through full initialisation or dialling memory or password clearing; Heard from the loudspeaker while the switch is activated by keypad.
"Attention, your call is being terminated"		signals that the preset maximum call time will elapse within 10 seconds during outgoing and incoming calls
"Wait, please"		Optional message during call establishing
"Communicator number is calling"		Optional message for communicator identification
Voice menu		In the programming mode.

Call Termination Options - Summary

1. The busy or continuous tone *) after the call end.
2. The ringing tone *) after a predefined count of rings.
3. The subscriber 'at the other end' pressed [#].
4. The preset maximum call duration has elapsed.
5. 30 seconds after the switch use has elapsed.
6. A **2N® Helios** button was pressed during the call.
7. The [#] keypad button was pressed during the call (can be disabled).

**) The communicator is able to detect a permanent tone, busy tone and ringing tone even if the tone has two frequency components as in the UK, the U.S.A. (the so-called BTT tone) and in Canada. This new function does not require setting of any parameter. One of the tone components must be of 440 Hz.*

Code Lock

The electronic lock connected to **2N® Helios** can not only be activated by the phone but also directly from the door using the keypad. In this mode, the keypad behaves like a standard code lock with the following features:



- Both switches can be controlled (if 2 connected)
- Password length - 1 to 16 digits;
- Up to 10 passwords per switch;
- Switch activation time - 1 to 9 seconds;
- Acoustic switch activation signalling – continuous tone.



The code lock uses the same passwords as the ones that have been defined for the telephone based switch control. Remember that the default passwords (**00** for switch 1 and **11** for switch 2) cannot be entered from the numerical keypad because they are notoriously known.

Control

Enter the correct password and [X]. If the password is valid, a long tone is transmitted for a predefined time (5seconds by default). The corresponding switch is activated during this time. If the password is invalid, **2N® Helios** sends a refusal signal.

Traditional Button Telephone

Any number can be “dialled” in this mode. To dial, press , and to hang up use .

These keys are typically provided with pictograms  and . PSTN calls can be barred for a line in the PBX. The dialling type (tone, pulse) is selected in the programming mode. With pulse dialling, the  character initiates (upon off-hook) transition to tone dialling – like on any other telephone.



Note

- If this function is enabled, you can press  to hang up an outgoing call initiated by pressing a separate button.

DTMF Transmission during Outgoing Call

This function enables the unit to transmit DTMF tones when the connection with one of the pre-programmed numbers has been established. It is used in combination with automatic information systems, voice mailboxes, etc., which ask the calling party to select a service using tone dialling. This function, however, does not allow you to call destinations other than the pre-programmed ones.

Buttons Substitution

This function is an analogy to memories in comfortable telephone sets. After two digits ranging between 01 and 54 (0 may not be omitted) are pressed, the call to the pre-programmed number is made. You can use **2N® Helios** as if it had up to 54 separate buttons, which saves buying the extender units and space on the installations wall. The ideal solution is to use a few standard buttons for the most important speed dialling options e.g. Warden, Reception and then provide a list of pre-programmed options via the optional info panel that can be purchased.

Admissible Keypad Function Combinations

All of the above mentioned 4 functions can be combined freely – each of them can be enabled or disabled separately as desired.

Keypad Operation Instructions - Summary

- **Door opening – code lock**

Enter any valid password for switch 1 and .

Warning! Password 00 may not be used!

- **Switch 2 activation:**

Enter any valid password for switch 2 and .

Warning! Password 11 may not be used!

- **Traditional button telephone**

gets **2N® Helios** ready to dial a number.

... Dials a number.

Transmits into tone dialling during pulse dialling.

Transmits a character in tone dialling.

Hangs up anytime during a call.

- **DTMF transmission during outgoing call**

(of a single button, not in the telephone mode!)

... - tone-dials a number.

- The character is sent normally.

- The character is sent normally.

- **Buttons substitution:**

01...54 – the number that complies with the selected button (memory) is dialled after a timeout.

- If an asterisk is pressed after number 01...54, the number is dialled immediately unless it is identical with the set password.

Frequently Asked Questions About Keypad Function

- **Can any of the switches be activated permanently?**
Yes, the additional switch can be activated by one password and deactivated by another.
- **Is it possible to arrange for the switch to be activated during the whole call?**
Yes, additional switch can do it.
- **Is it possible to use a single command to activate one switch first and the other later?**
Yes, it is possible to use parameter 824, Switch 2 delay.
- **Can both the switches be activated at the same time?**
While one switch is activated, the other can be activated by another password. You can also use parameter 824, Switch 2 delay, defining the shortest delay time possible (1second) and a sufficiently long switch activation time.
- **Can I use the code lock while another person is speaking through 2N® Helios?** Yes but this is not advisable as you should be aware that the password is private and could contravene security.
- **What happens when I press a number with no pre-programmed memory while the button replacing function is enabled?** The same as if you pressed a button that is not pre-programmed: 2N® Helios seizes the line, beeps refusal (refer to Signalling) and hangs up immediately.
- **What happens if a password is identical with the memory number while the code lock and button substituting functions are enabled?** The code lock function has the highest priority. If, for example, the password is 33 and you press **33***, the switch is activated instantaneously. If you press **33** without an asterisk, the line is seized after a preset delay and the number from memory 33 is dialled.



Password Selection Tips

- Keyboard letters facilitate password remembering. For example, it is easier to remember a 9-letter word (e.g. crocodile) than a 9-digit number (276263453).
- It is not recommended to use such passwords as 3333. This leads to a considerable wear and tear of one button and an unauthorised person may guess your password easily. It is ideal to employ all keys evenly, using several codes for different persons or groups.

2N® Helios Statuses and Available Operations

Operation		Hang-up	Outgoing call	Incoming call	Programming	Telephone mode
Button pressing – new call		✓	x	---	---	✓
Call extension - DTMF ☒		---	✓	✓	---	✓
Call termination - DTMF #		---	✓	✓	✓	✓
Hang-up upon continuous, busy or ringing tone		---	✓	✓	✓	✓
Switch activation – DTMF password		---	x	x	---	x
Programming start		---	---	✓	---	---
Keypad	Switch activation – code lock	x	x1)	---	---	---
	DTMF into outgoing call	---	x	---	---	✓2)
	Button replacing (speed dial from memory)	x	x1)	---	---	---
	Off-hook by key ☒ (into telephone mode)	x	---	---	---	---
	Hang-up by key #	---	✓1)	---	---	✓
	Hang-up by key ☒	---	✓1)	---	---	---

Explanatory notes:

✓... Yes, always

x ... Yes if this function is programmed

This holds if DTMF is disabled during outgoing calls (the corresponding tone is transmitted in that case).

If pulse dialling is selected, it is possible to switch into tone dialling by pressing ☒ (but not vice versa!).

4.2 Section for Advanced Users

Automatic Multiple Number Dialling

When you press a **2N® Helios** button, you may find out that the called line is busy or the called party is absent. **2N® Helios** is able to identify these situations and solve them by Automatic Multiple Number Dialling if one of three automatic dialling modes is enabled. Up to 6 numbers can be stored for each button.

The three automatic modes (see below) recognise the continuous, busy and ringing tones. In all of these modes, automatic dialling can be disabled or the required count of cycles can be preset (1 to 9; if none of the stored numbers is answered, the whole cycle is repeated starting with the first number again) for each button separately.

You can program Automatic Multiple Number Dialling for selected buttons only, retaining the others in the default mode, the selection of one of three automatic dialling modes is common.

Automatic Multiple Number Dialling without Confirmation

This mode can be used in common cases to enable the visitor to get through even if the called line is busy or the called subscriber is absent. Hence, the second memory of the button may include the secretary's number, the third memory the porter's lodge number, etc.

This mode recognises the ringing tone and if the tone ends before the predefined count of rings, **2N® Helios** regards this as a successful connection, this solution is not fully reliable because detection may be hindered by noise, etc. No message is played back in this mode.

Evaluation of Situations in Audible Automatic Dialling without Confirmation

Situation	2N® Helios Action
Busy tone	Hangs up in approximately 2 seconds and dials the next number.
Call or silence without previous ringing tone	Waits for the preset timeout (log-in time), then hangs up and dials the next number.
Continuous tone (at the PBX, e.g.)	Hangs up in approximately 2 seconds and dials the next number.
Ringing tone, which is terminated before 10 rings are made (the count of rings is variable)	Regarded as a successful call, continues for the maximum timeout (maximum call duration). For details refer to the text under the table.
Ringing tone, 10 rings are made (the count of rings is variable)	Hangs up and dials the next number.
1 to 9, 0	These digits are interpreted as password beginning.
*	Call extension or password beginning.
#	Hang-up command.

If the ringing tone stops before the predefined count of rings is achieved and the call is thus very short (e.g. 2 seconds), it is not clear whether the call should be regarded as successful. Therefore, a new type of automatic dialling has been added - type 4.

The difference is as follows:

- Type 3 regards such a call as successful only if the door is opened.
- Type 4 regards all such calls as successful.

Automatic Multiple Number Dialling with Confirmation

This mode is used where maximum connection reliability is required – for emergency calls. The called line (the supervisory control centre, e.g.) must be operated by a well-trained person to confirm connection. The DTMF is used as the most reliable criteria for successful connection. The called line must press **1** on its telephone. If the called number is busy or remains unanswered until the preset timeout or in other cases (see the table), **2N@ Helios** dials the next number in the sequence.

Evaluation of Situations in Audible Automatic Dialling with Confirmation

Situation	2N@ Helios Action
Busy tone	Hangs up in approximately 2 seconds and dials the next number.
Call or silence	Waits for the preset timeout (log-in time), then hangs up and dials the next number.
Ringing tone	Waits for the preset count of rings, then hangs up and dials the next number.
Continuous tone (at the PBX, e.g.)	Hangs up in approximately 2 seconds and dials the next number.
DTMF char 5 or #	Immediately hangs up and dials the next number.
DTMF char 1	Confirms reception (2 beeps) and the call continue for the preset time at most (maximum call duration).
1 2 3 4 5	These digits are interpreted as control characters - refer to the DTMF Control subsection.



Note

- It is sometimes difficult to recognise the above-described situations reliably due to a poor quality of the PSTN connection. Excessive noise in the surroundings may also have a negative impact. However, this may only decelerate automatic dialling (the busy tone may not be recognised, e.g.). Even if **2N@ Helios** cannot identify the DTMF, the connection is established (yet for a shorter time).

Silent Automatic Multiple Number Dialling

This mode fully conceals the fact that a telephone call is made. When a button is pressed, the loudspeaker is off and no PBX or dialling tone can be heard. The loudspeaker is switched on when the called subscriber confirms connection (by pressing  on its telephone). Thus, a potential thief cannot establish whether the called person is in the building or not.











Otherwise, the function is the same as with Automatic Multiple Number Dialling with Confirmation.

2N® Helios Identification

There are situations in which the calling person does not want to or cannot speak for security reasons in the automatic dialling mode. In these cases, **2N® Helios** can play back a message stored in its memory. The test series includes the "Wait please, connection is being established" message. Later, more messages will be available to the user.

DTMF Control

If Automatic Multiple Number Dialling with Confirmation or Silent Automatic Multiple Number Dialling is enabled, **2N® Helios** can be controlled as shown in the table below. For convenience, commands 1 to 5 are arranged as they are usually used.

DTMF Character	FUNCTION
	Confirmation indicating to 2N® Helios that a call was successful. 2N® Helios sends its confirmation signal, the call goes on until the end of timeout and any of the following commands can be used.
	Message muting (during playback). WARNING! You may not speak while 2N® Helios is playing back the message!!!
	Message re-plays (once).
 or 	Call extension: a call is extended by 30 seconds by this command. Can be used repeatedly.
 or 	Call termination .
 to  , 	These digits are interpreted as a password beginning - for switch control.



Notes

- These commands do not work in the Automatic Multiple Number Dialling mode without Confirmation!
- The above-mentioned commands **may not be accepted** due to poor connection if sent during a message. To avoid this, press the button during the time of silence (between messages).

Survey of Messages

The table below includes a survey of language versions for standard announcements. English is selected by default. To select another language, use parameters 976 and 977.

Value of parameter 976	Language selection – English version	End of call message	Outgoing call message	
			ID message. Parameter 975 must contain digit 2, 3 or 5	Confirmation message. Parameter 975 last digit = 5
0	Tone signal		off	off
1 (default value)	English	Attention, your call is being terminated.	Communicator number..... is calling .	Connection confirmed.
2	German	Achtung, das Gespräch wird beendet.	Es ruft das Notruftelefon Nummer.....an.	
3	Portuguese	
4	Dutch	

Value of parameter 977	Language selection – English version	Outgoing call message	Note
0	Tone signal	off	<ul style="list-style-type: none"> • To play this message, parameter 975 must start with digit 5. • Parameter 977 has a range 0 – 99. On customer's request, additional messages can be added; e.g. other languages or more alternative messages in one and the same language.
1 *	English	Wait please.	
2	German	Warten Sie bitte.	
3	Portuguese	
4	Dutch	

Arrival/Departure, Day/Night Modes

2N® Helios can identify easily where to 'route' (switch) a call after a button is pressed. All you have to do is call **2N® Helios** and enter the following:

I'm leaving: ☒ password ☒ 1 ☒

I'm back: ☒ password ☒ 0 ☒

All buttons can be switched all at once by a common **Day/Night password** or individually by separate **Departure/Arrival passwords**.

How does switching work?

- Every button has memories for 6 numbers (intended primarily for Automatic Multiple Number Dialling).
- If the Automatic Multiple Number Dialling mode is **OFF**, memory **1** is used for the Day mode and memory **3** for the Night mode. This is a simple two-number switching.
- If the Automatic Multiple Number Dialling mode is **ON**, memories **1, 2, 3, 4, 5, 6** are used for the Day mode and memories **3, 4, 5, 6** are used for the Night mode in the above-mentioned order. This accelerates the process; numbers that would not be answered are skipped over.
- If the Night mode is on and memories 3 to 6 are empty, memories 1 and 2 are used.
- If the **Night** mode is on, memories 1 and 2 are omitted for **all** buttons and this cannot be disabled individually using the Arrival function.
- In the Day mode, the buttons assigned to persons who used the Departure function (are on a leave) shall remain in the Night mode until the same persons use the Arrival function (after the leave, e.g.).

Example 1 – administration building, automatic dialling is off:

Button 01: labelled Mr. Smith, memory 1 = Mr. Smith's line, memory 3 – secretary's line, password for button 01 is 777.

1. *Mr. Smith is leaving for holiday. He calls **2N® Helios** and enters: ☒777☒1☒*
2. *A visitor comes, presses Mr. Smith's button – **2N® Helios** calls the secretary.*
3. *Mr. Smith comes back. He calls **2N® Helios** and enters: ☒777☒0.*

Example 2 – family house, Silent Automatic Multiple Number Dialling:

Button 01: labelled The Johnsons, memory 1 = living room, 2 = workshop, 3 = Mr. Johnson's mobile telephone, 4 = Mrs. Johnson's mobile telephone. Arrival/Departure password for button 01 is 333.

1. *The family is leaving for holiday. They call **2N® Helios** and enter: ☒333☒1☒.*
2. *A visitor presses the Johnson's' button – **2N® Helios** calls Mr. Johnson's mobile phone and, if unsuccessful, Mrs. Johnson's mobile phone.*

4.3 Maintenance

Cleaning

If used frequently, 2N® Helios, especially the keypad, gets dirty. To clean it, use a piece of soft cloth moistened with clean water. We recommend you to obey the following principles while cleaning:

- Never use aggressive detergents (such as abrasives or strong disinfectants);
- Clean the device in dry weather in order to make waste water evaporate quickly.

Label Replacement, Programming Status Changes

For necessary steps refer to the preceding subsections. Keep the following for later changes:

- this manual;
- the completed programming form (including a copy);
- unused transparent foil strips for button labels.

Always use the product for the purpose it was designed and manufactured for, in compliance herewith.

The manufacturer reserves the right to modify the product in order to improve its qualities.

2N Helios contains no environmentally harmful components. When the product's service life is exhausted and you would like to dispose of it please do so in accordance with applicable legal regulations.

5

Technical Parameters

This section describes the technical parameters of the product.

5.1 Technical Parameters

Telephone Parameters

Parameter	Value	Conditions
Minimum required off-hook line current	15 mA	Off-hook
Minimum required on-hook line voltage	20 V	Hang-up
DC voltage drop (off-hook)	< 8 V < 16 V	I = 25 mA I = 50 mA
Lead current while hang-up	< 25 μ A	U = 60 V
Off-hook AC impedance	220 Ω + 820 Ω 115 nF parallel	20 to 60 mA
Return loss	> 10 dB	20 to 60 mA
Bandwidth	300 to 3500 Hz	20 to 60 mA
Ringing impedance	> 2 k Ω C = 1 μ F	25 to 50 Hz
Ringing detector sensitivity	10 to 20 V	25 to 50 Hz
Time of response to ringing	Variable	
Pulse dialling	40 / 60 ms	20 to 60 mA
DTMF level	-6 and -8 dB \pm 2 dB	20 to 60 mA
DTMF detector sensitivity	Min. -40 dB	20 to 60 mA
Dial tone detector sensitivity	Min. -40 dB	350 - 500 Hz
Busy tone detection speed	Variable	350 - 500 Hz
Continuous tone detection speed	Variable	350 - 500 Hz
Ringing tone detection speed	Variable	350 - 500 Hz
Overvoltage protection – common mode	1000 V	8 / 20 μ s
Overvoltage protection – between A, B conductors	1000 V	8 / 20 μ s

Other Parameters

Switch – max. voltage	48 V AC, DC
Switch – min., voltage	9 V AC, DC
Switch – max. current	2 A AC, DC
Backlight – rated voltage	12 V
Backlight – max. voltage	24 V
Backlight – current consumption	up to 1 A
Operational temperature range	-20 to + 60 °C
Coverage	IP 53
Dimensions (1 module)	210x100x29 mm (h x w x d)
Weight	up to 500 g

6

Supplementary Information

This section provides supplementary information of the product.

Here is what you can find in this section:

- Regulations and Directives

6.1 Directives, Laws and Regulations

2N[®] Helios conforms to the following directives, laws and regulations:

- Act No. 22/1997 Coll. Of January 24, 1997 on technical requirements of products and amendments to some laws
- Directive 1999/5/EC of the European Parliament and of the Council, of 9 March 1999 – on radio equipment and telecommunications terminal equipment and the mutual recognition of their conformity
- Governmental Regulation No. 426/2000 Coll. on technical requirements of radio and telecommunications terminal equipment
- Directive 2006/95/EC of the European Parliament and of the Council of 12 December 2006 on the harmonisation of the laws of Member States relating to electrical equipment designed for use within certain voltage limits
- Governmental Regulation No. 17/2003 Coll. on technical requirements of low voltage electrical equipment
- Directive 2004/108/EC of the Council of 15 December 2004 on the harmonisation of the laws of Member States relating to electromagnetic compatibility
- Governmental Regulation No. 616/2006 Coll. on technical requirements of products in terms of electromagnetic compatibility
- Directive 2002/95/EC of the European Parliament and of the Council of 27 January 2003 on the restriction of the use of certain hazardous substances in electrical and electronic equipment
- Regulation (EC) No. 1907/2006 of the European Parliament and of the Council of 18 December 2006 concerning the Registration, Evaluation, Authorisation and Restriction of Chemicals (REACH), establishing a European Chemicals Agency, amending Directive 1999/45/EC and repealing Council Regulation (EEC) No. 793/93 and Commission Regulation (EC) No. 1488/94 as well as Council Directive 76/769/EEC and Commission Directives 91/155/EEC, 93/67/EEC, 93/105/EC and 2000/21/EC
- Directive 2002/96/EC of the European Parliament and of the Council of 27 January 2003 on waste electrical and electronic equipment

6.2 Troubleshooting

FAQ

For tips concerning solutions of other potential problems see faq.2n.cz.

6.3 General Instructions and Cautions

Please read this User Manual carefully before using the product. Follow all instructions and recommendations included herein.

Any use of the product that is in contradiction with the instructions provided herein may result in malfunction, damage or destruction of the product.

The manufacturer shall not be liable and responsible for any damage incurred as a result of a use of the product other than that included herein, namely undue application and disobedience of the recommendations and warnings in contradiction herewith.

Any use or connection of the product other than those included herein shall be considered undue and the manufacturer shall not be liable for any consequences arisen as a result of such misconduct.

Moreover, the manufacturer shall not be liable for any damage or destruction of the product incurred as a result of misplacement, incompetent installation and/or undue operation and use of the product in contradiction herewith.

The manufacturer assumes no responsibility for any malfunction, damage or destruction of the product caused by incompetent replacement of parts or due to the use of reproduction parts or components.

The manufacturer shall not be liable and responsible for any loss or damage incurred as a result of a natural disaster or any other unfavourable natural condition.

The manufacturer shall not be held liable for any damage of the product arising during the shipping thereof.

The manufacturer shall not make any warrant with regard to data loss or damage.

The manufacturer shall not be liable and responsible for any direct or indirect damage incurred as a result of a use of the product in contradiction herewith or a failure of the product due to a use in contradiction herewith.

All applicable legal regulations concerning the product's installation and use as well as provisions of technical standards on electric installations have to be obeyed. The manufacturer shall not be liable and responsible for damage or destruction of the product or damage incurred by the consumer in case the product is used and handled contrary to the said regulations and provisions.

The consumer shall, at its own expense, obtain software protection of the product. The manufacturer shall not be held liable and responsible for any damage incurred as a result of the use of deficient or substandard security software.

The consumer shall, without delay, change the access password for the product after installation. The manufacturer shall not be held liable or responsible for any damage incurred by the consumer in connection with the use of the original password.

The manufacturer also assumes no responsibility for additional costs incurred by the consumer as a result of making calls using a line with an increased tariff.

Electric Waste and Used Battery Pack Handling



Do not place used electric devices and battery packs into municipal waste containers. An undue disposal thereof might impair the environment!

Deliver your expired electric appliances and battery packs removed from them to dedicated dumpsites or containers or give them back to the dealer or manufacturer for environmental-friendly disposal. The dealer or manufacturer shall take the product back free of charge and without requiring another purchase. Make sure that the devices to be disposed of are complete.

Do not throw battery packs into fire. Battery packs may not be taken into parts or short-circuited either.

Satelco

automation integration communication

Satelco AG

Seestrasse 241, CH-8804 Au

Tel.: +41 44 787 06 07, Fax: +41 44 787 06 08

E-mail: Satelco@satelco.ch

Web: www.satelco.ch

DR1322 v3.1